

WORLD OF
DEUSLAIR
DUNGEONS & LASERS



**REGULAR STRETCH GOALS
+ COMMUNITY SG**

MANUAL

KRIL CONSCRIPT

SPRUE: Stretch Goals 1

1

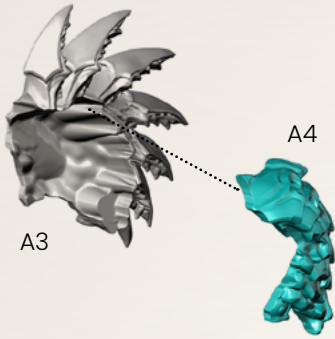

2

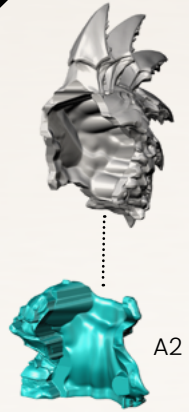

3

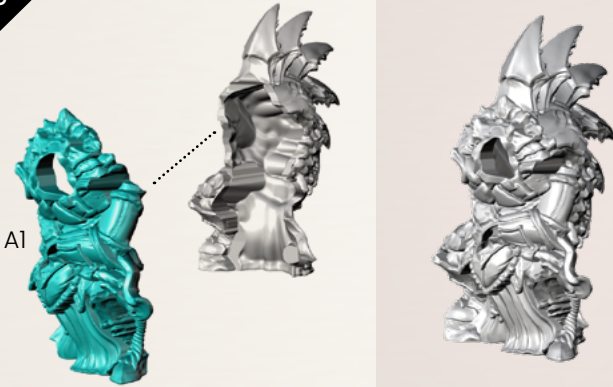

4



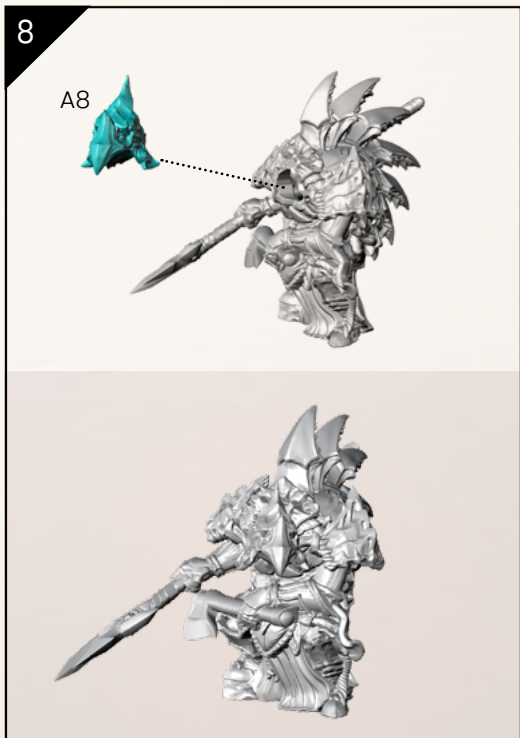
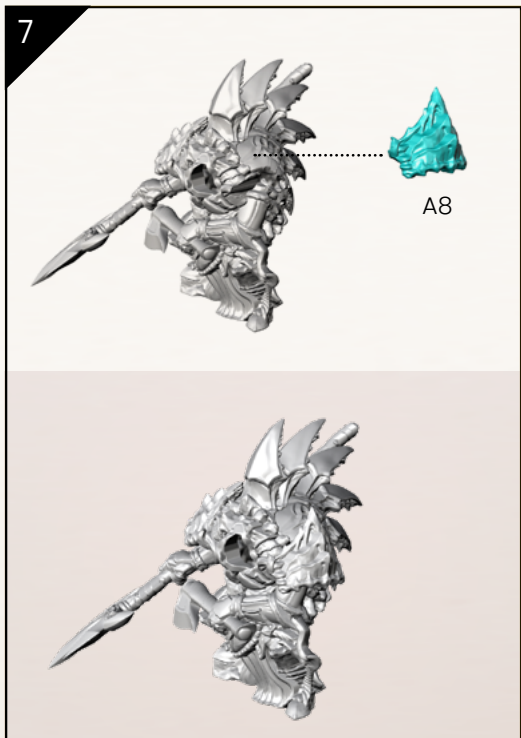
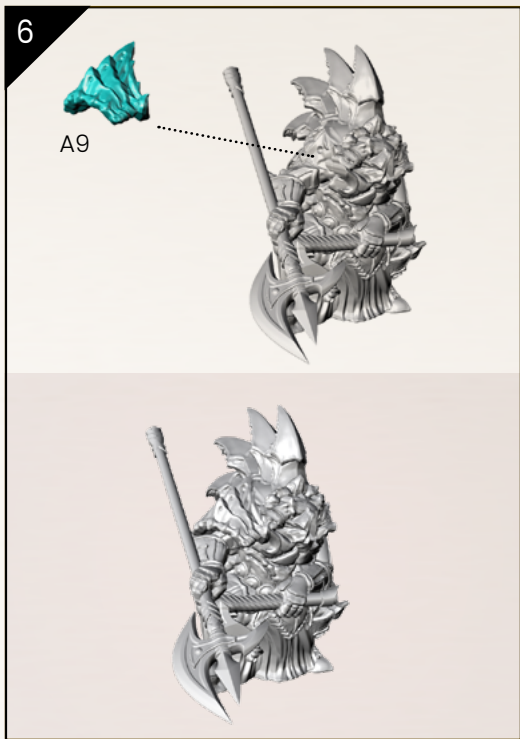
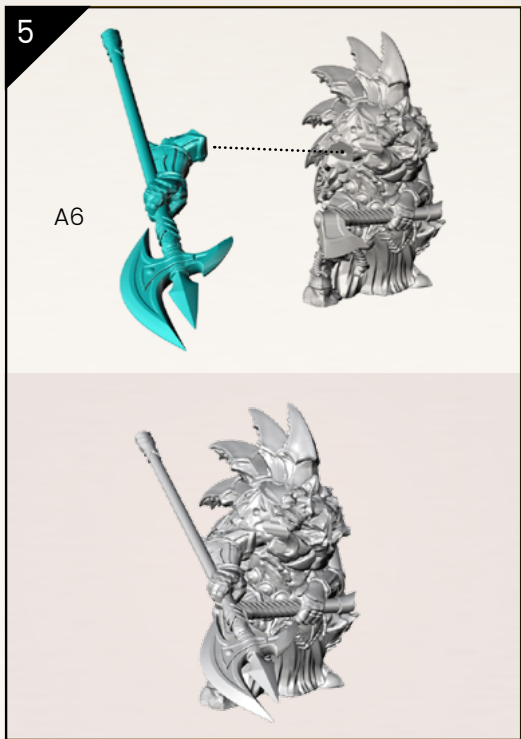

COURT AGENT

SPRUE: Stretch Goals 1

1

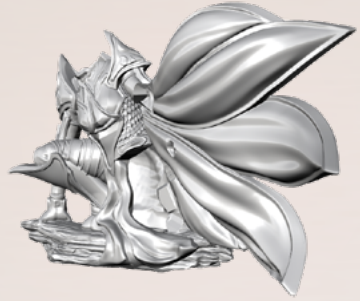
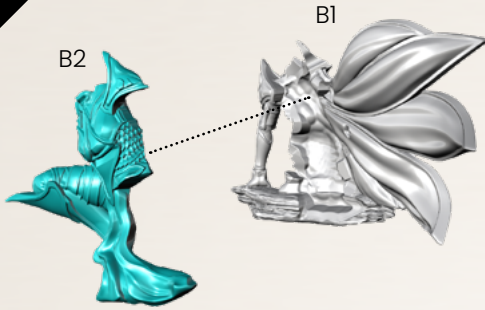

2

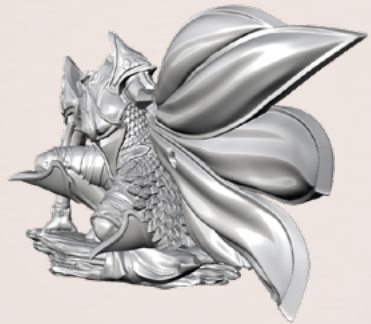
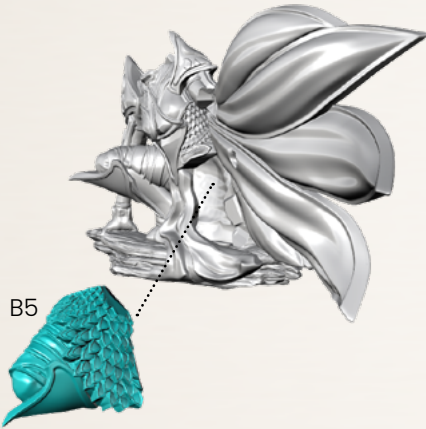

3





CHAMPION OF LAY

SPRUE: Stretch Goals 1

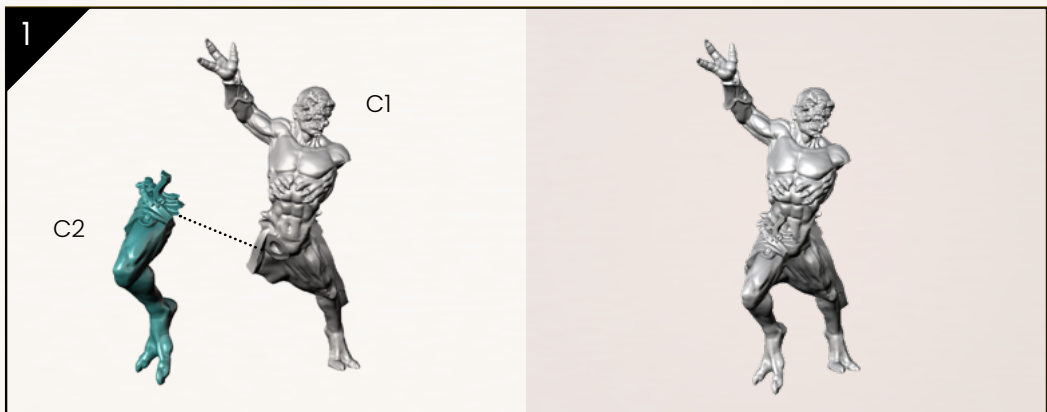

3

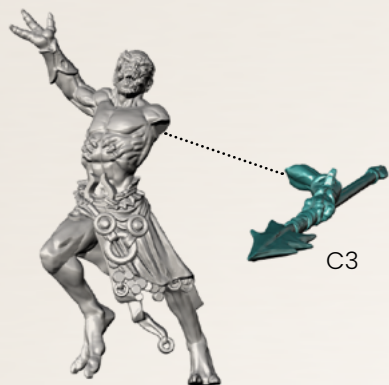

C3



4

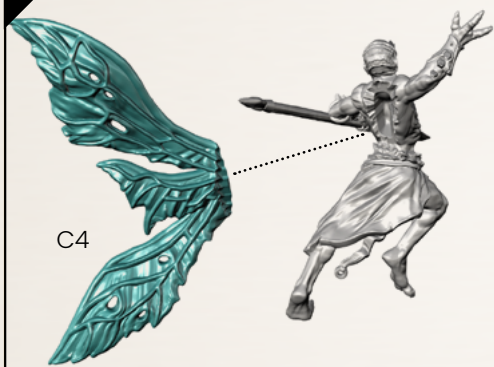

C4



5

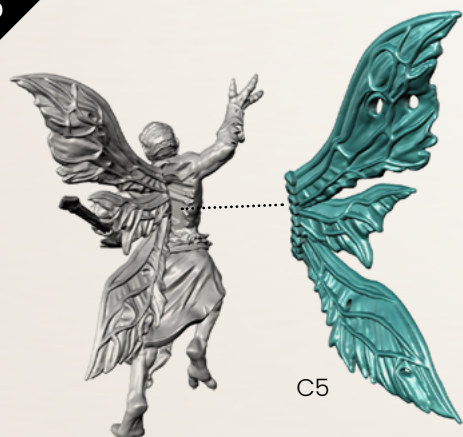

C5



MAD GOBLIN SCIENTIST

SPRUE: Stretch Goals 5

1

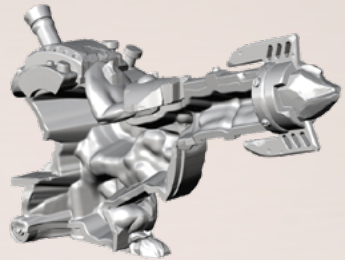
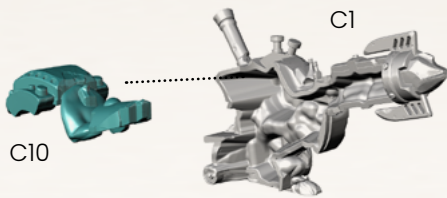

2

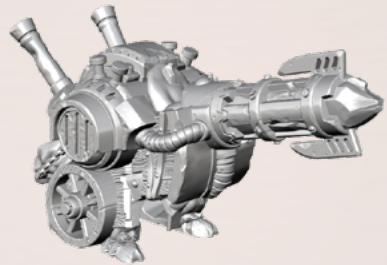
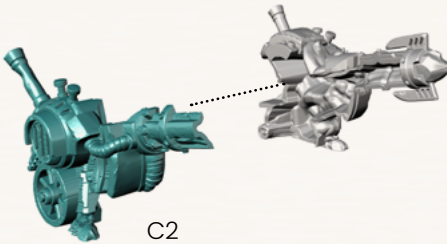

3

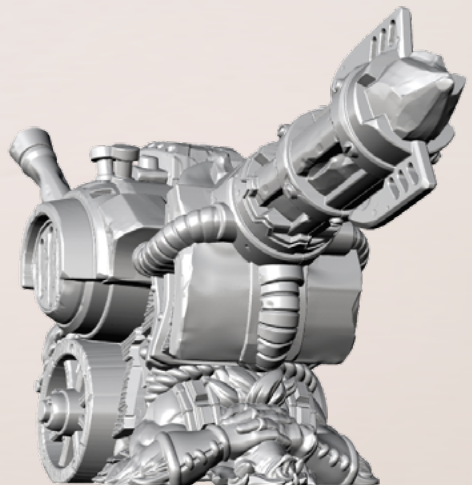
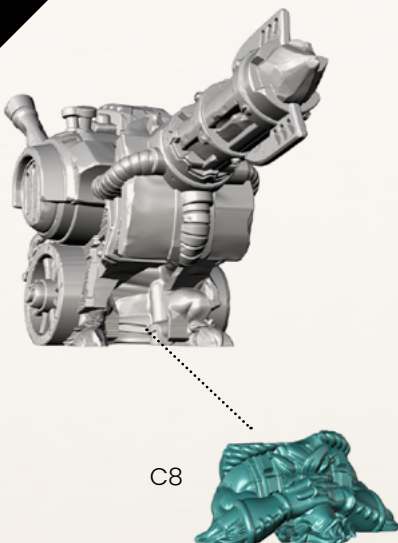

4

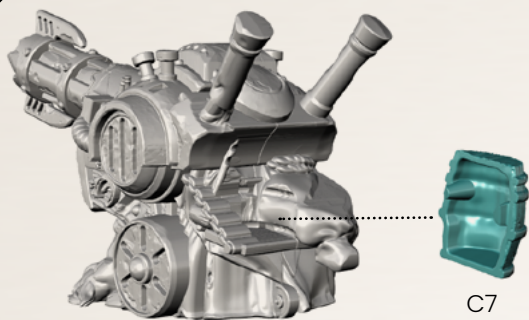

C7

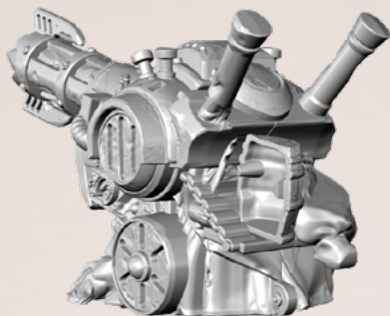

5

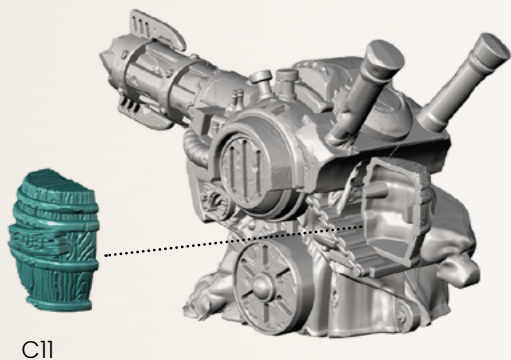

C11

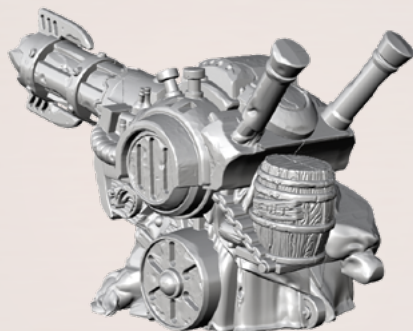

6

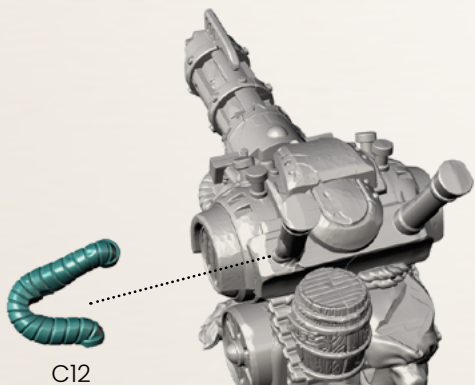

C12

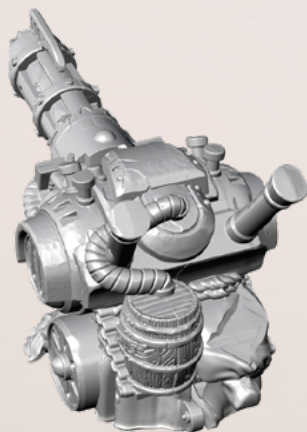

7

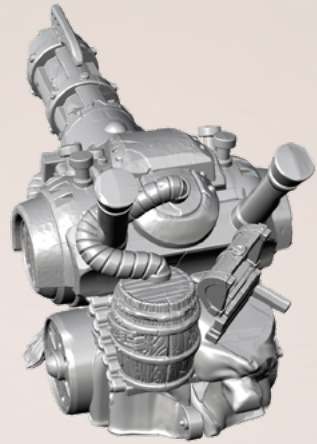
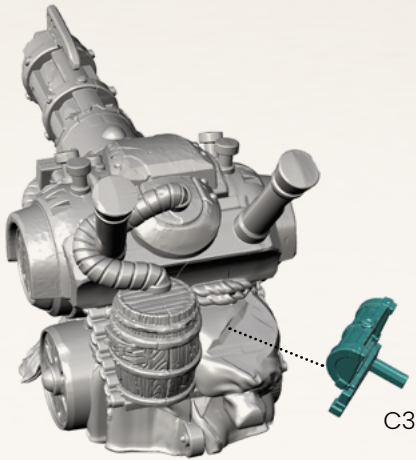

8

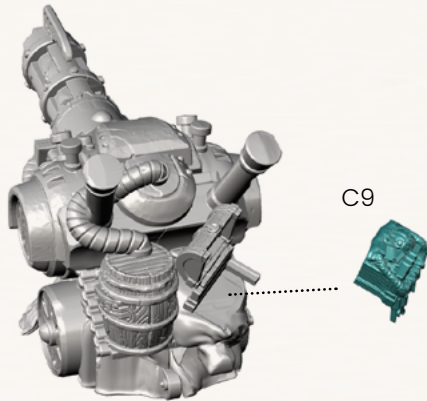

9

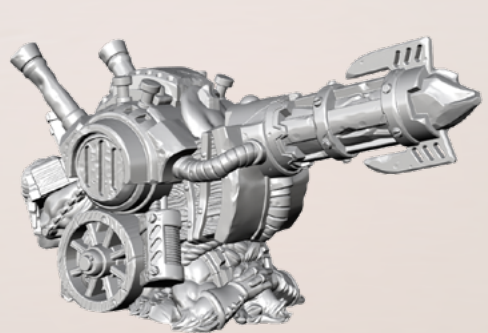
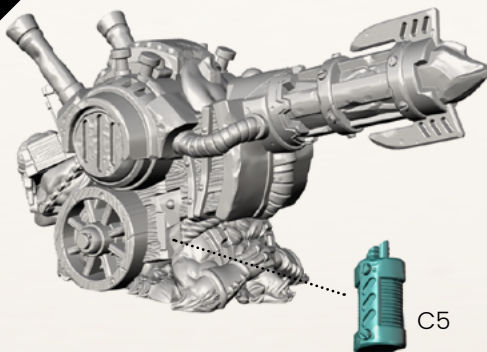

10

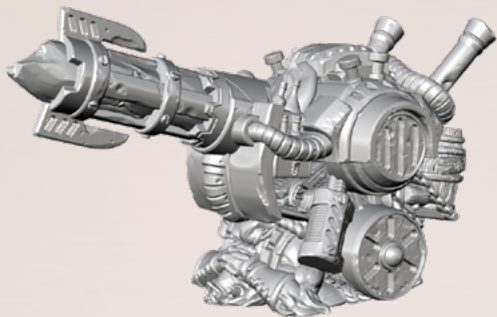
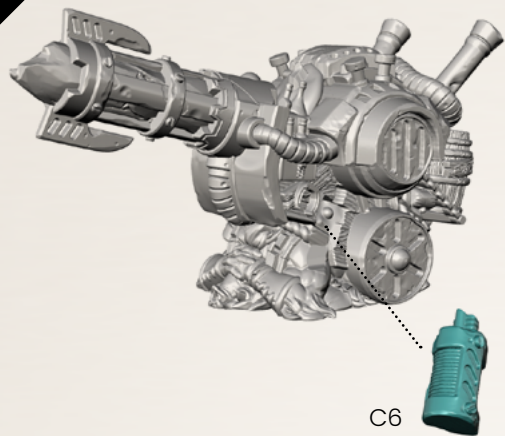

11

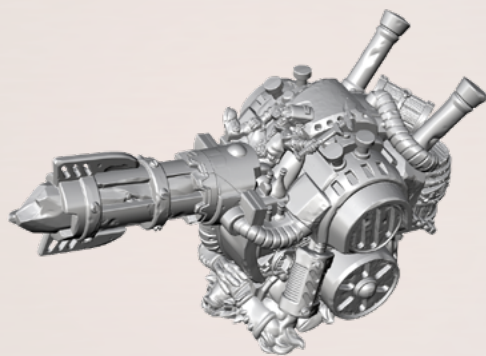
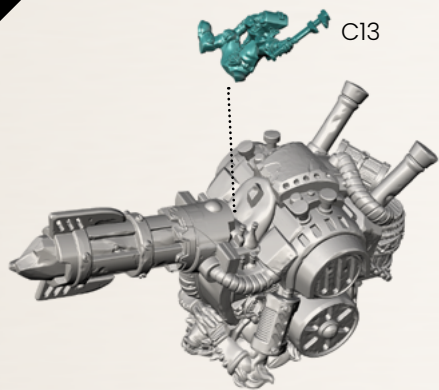

12

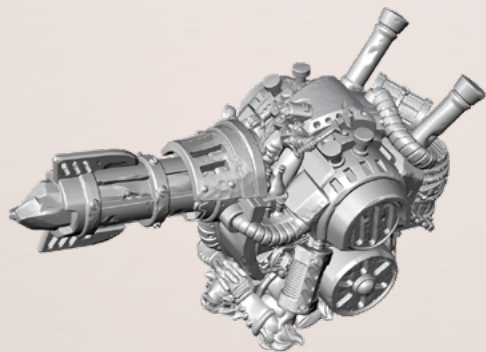
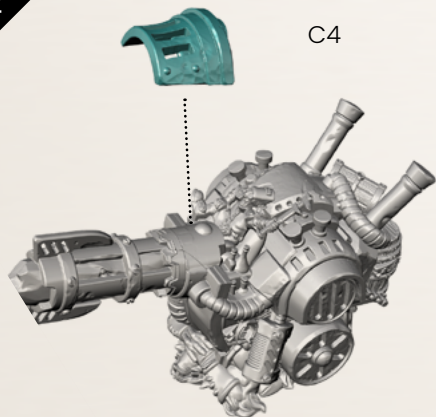

DRAGON HUNTRESS

SPRUE: Stretch Goals 12

1

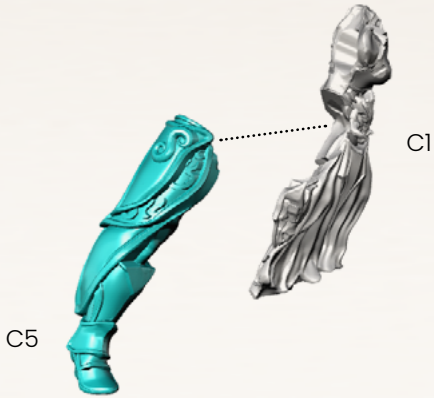

2

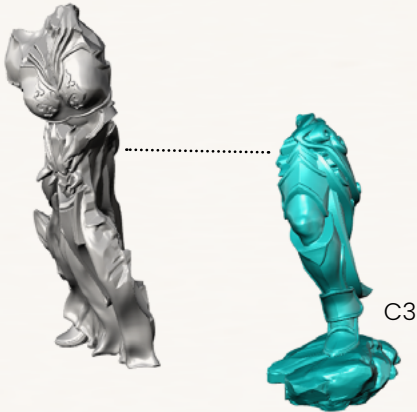

3

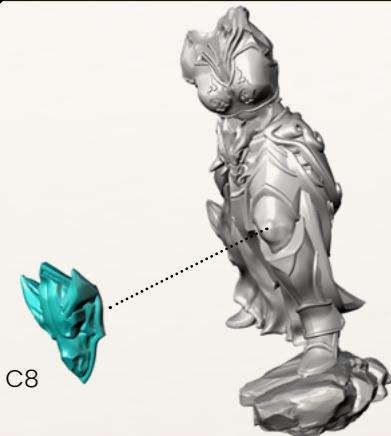

4

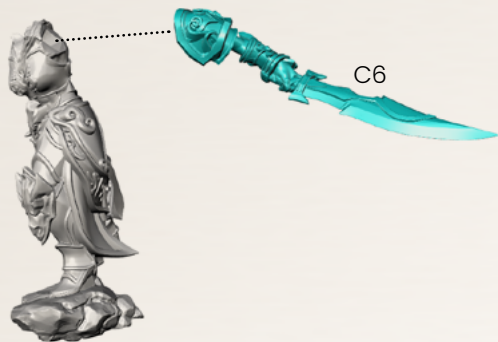

C6



5



C2



7



C4

6



C7



VESHT (WARERAT MERCHANT)

SPRUE: Stretch Goals 8

1

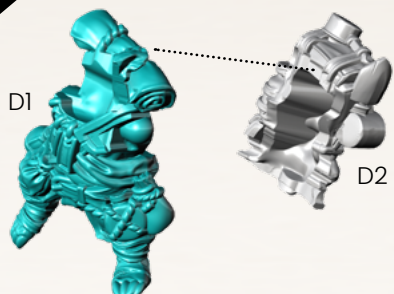

2



3

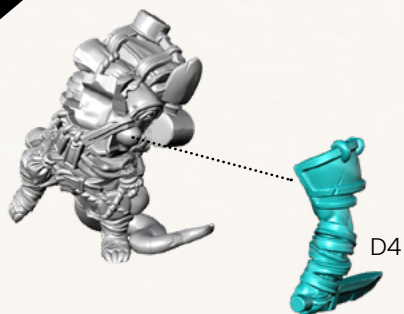

4

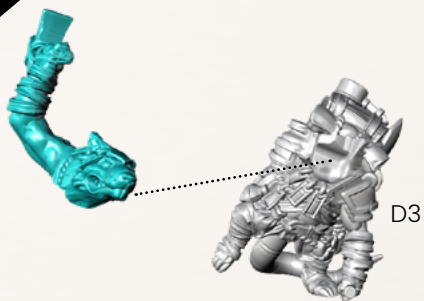

DISPLACED RIDER

SPRUE: Stretch Goals 16

1

D2

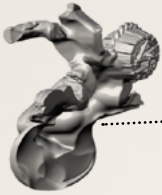

D3



2

D4

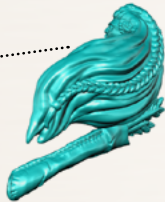

3

D1

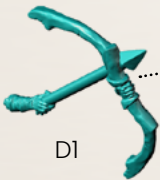

RUNIC GOLEM FOREST

SPRUE: Stretch Goals 4

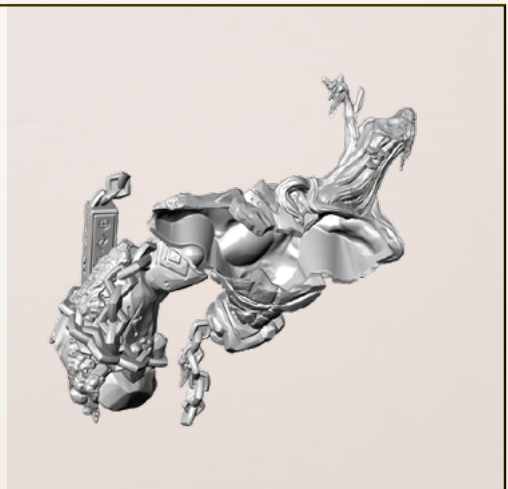
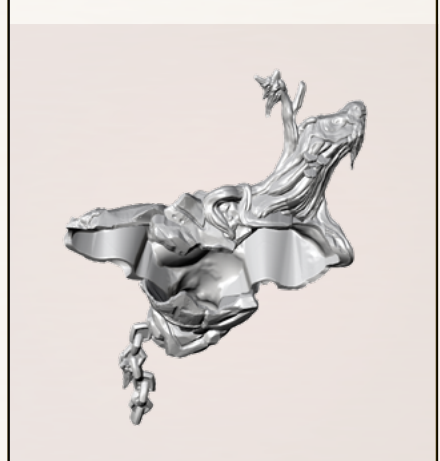
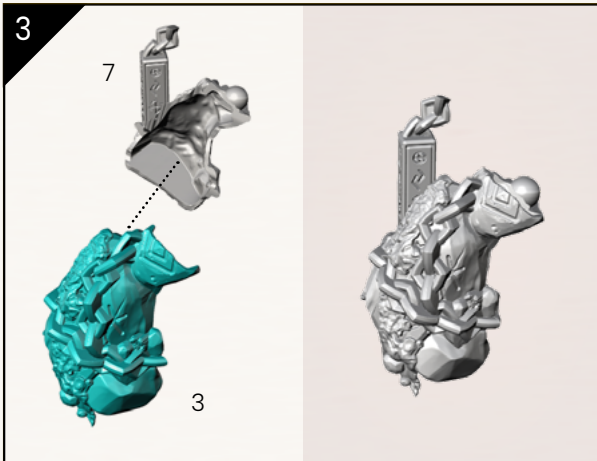
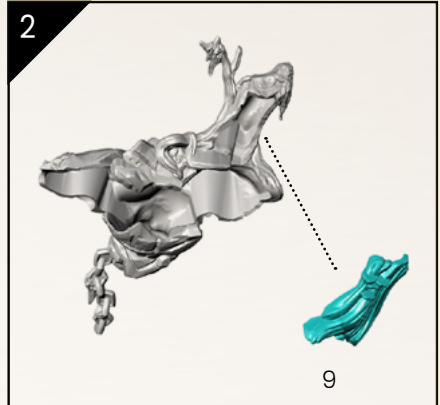
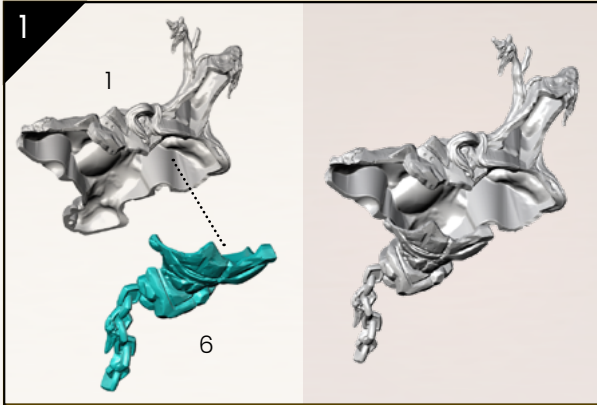

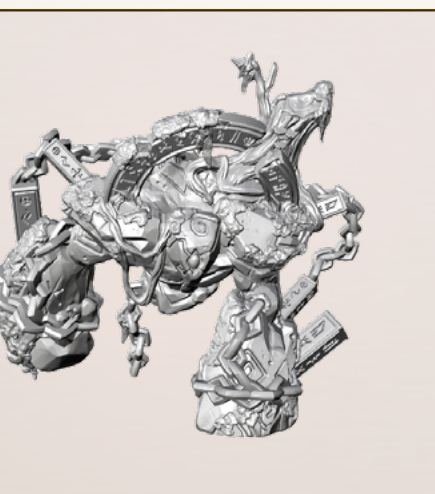
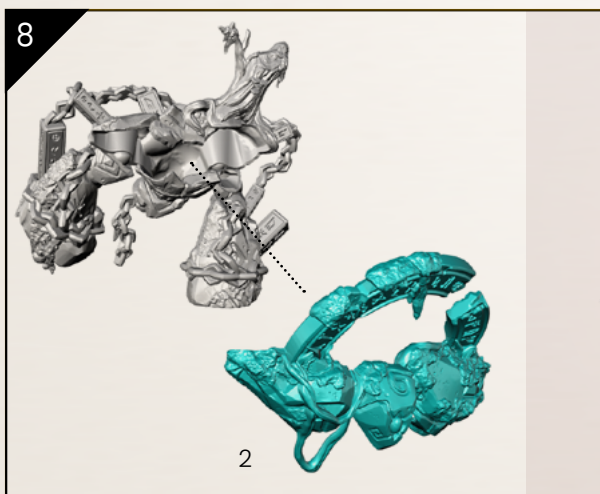
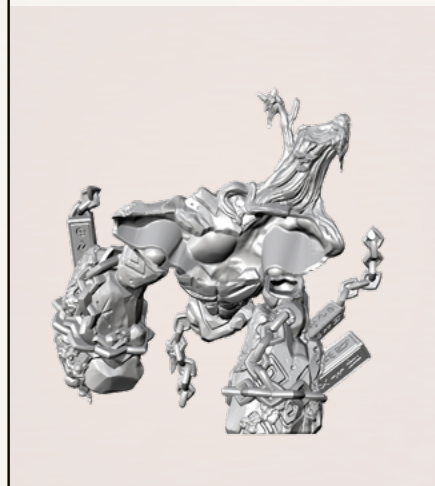
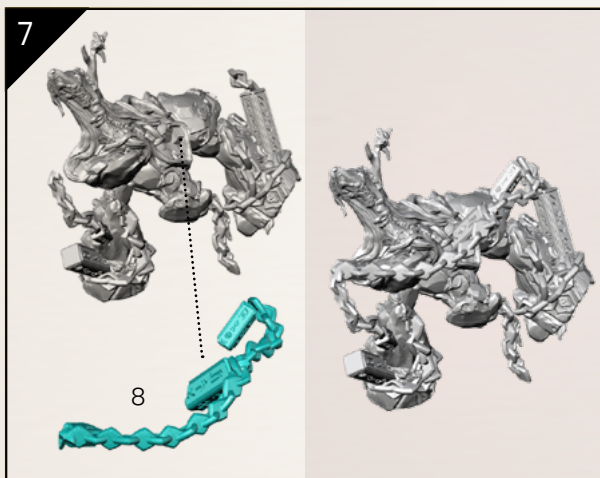
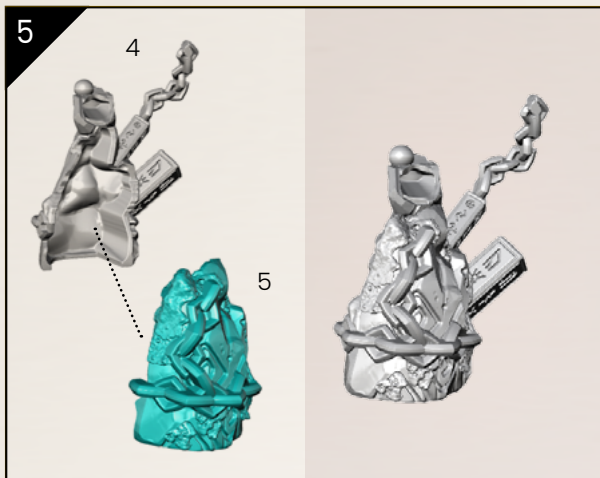

RUNIC GOLEM ANCIENT TEMPLE

SPRUE: Stretch Goals 3

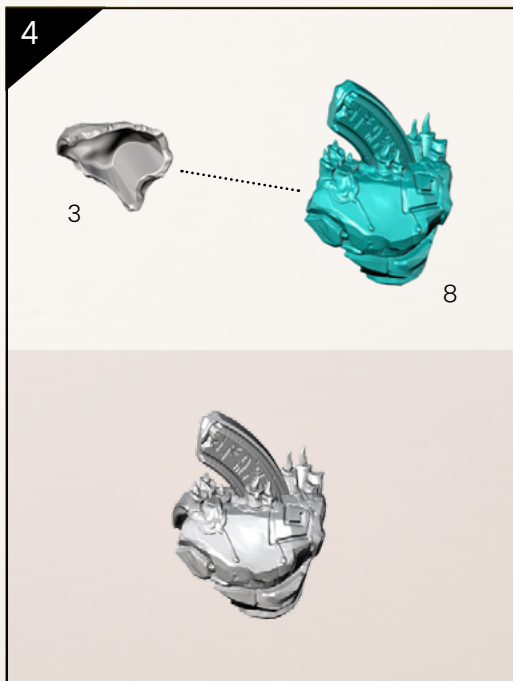
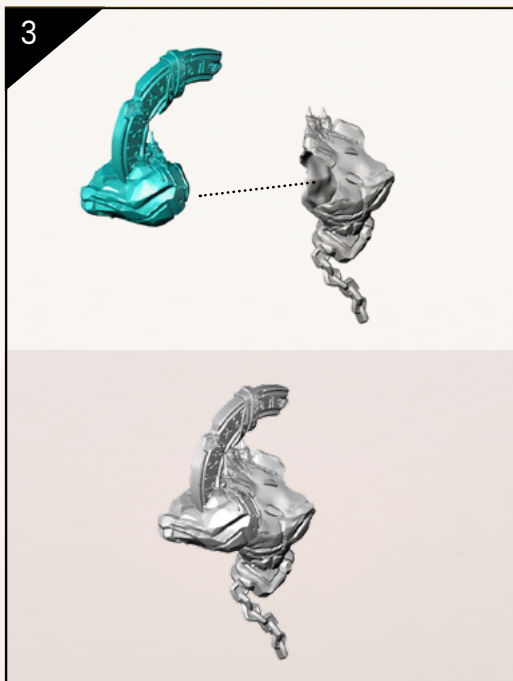
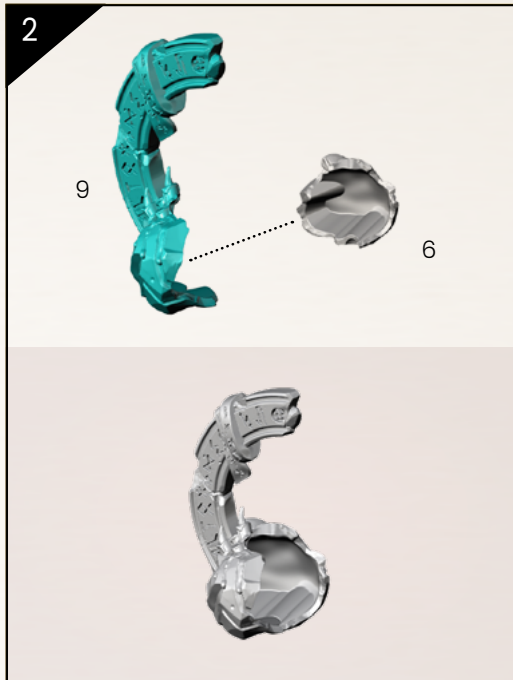
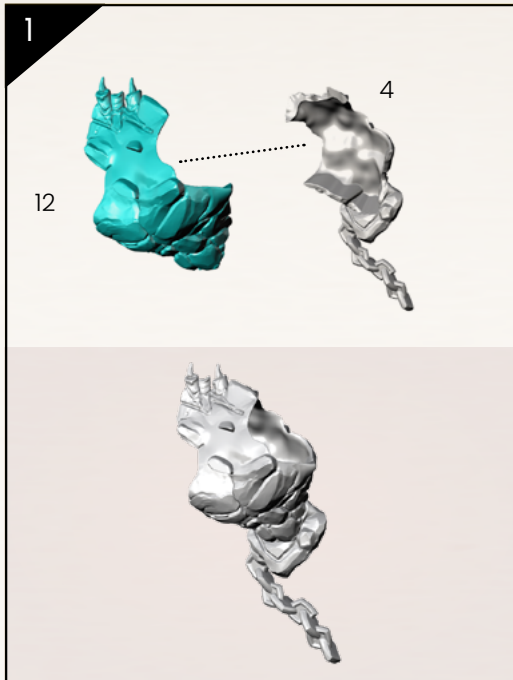

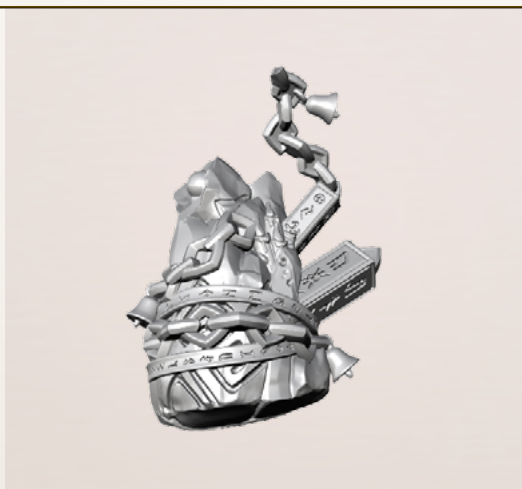
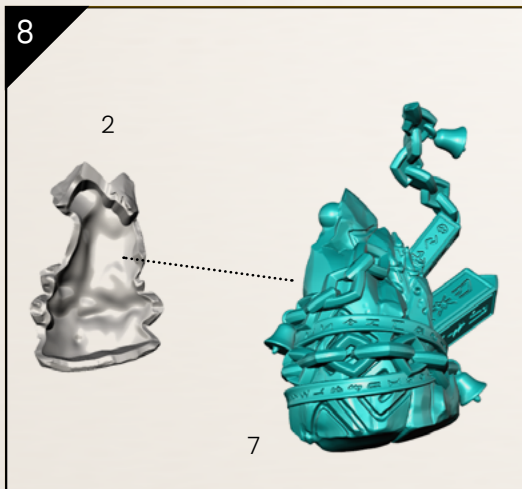
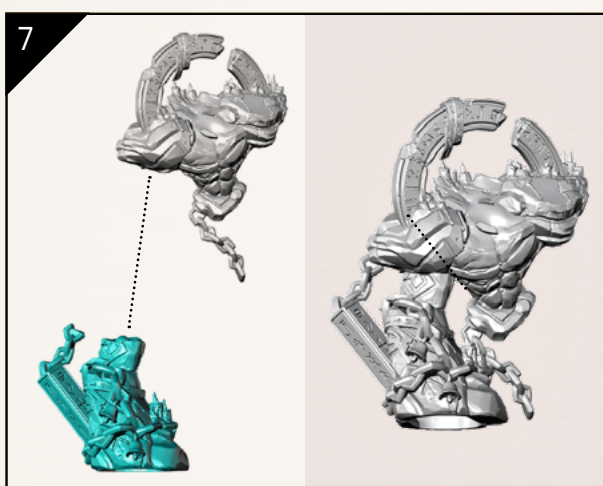
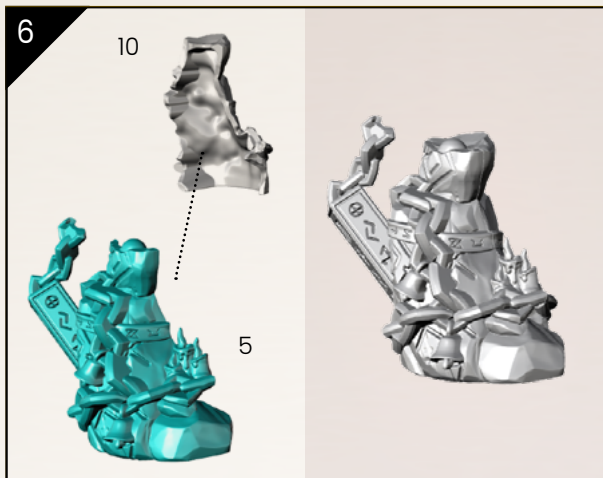
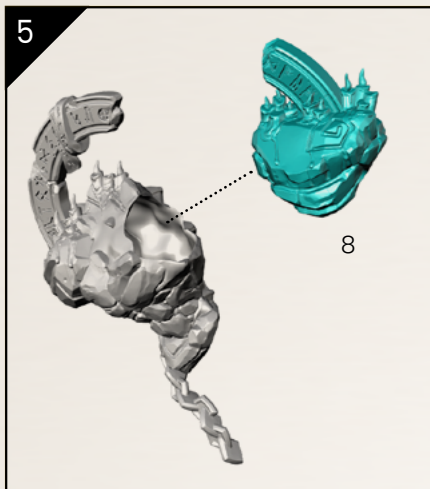

9

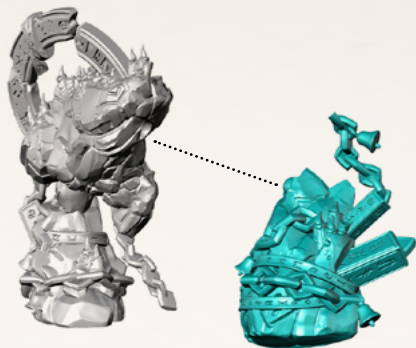

10

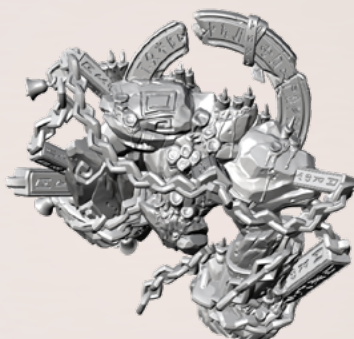
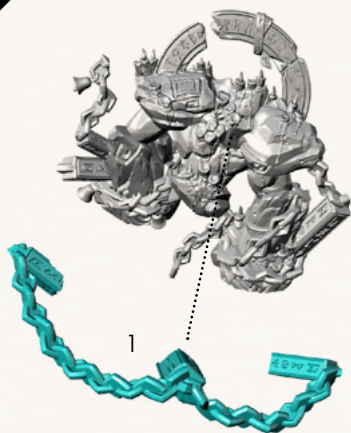

11

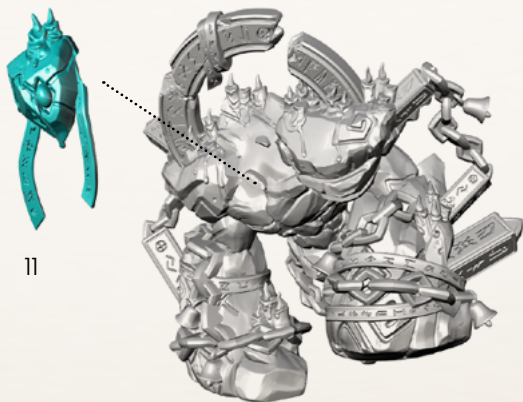

DUVAK (WERERAT ASSASSIN)

SPRUE: Stretch Goals 2

1

F2



F1

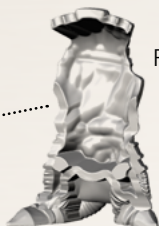

2



F3



F4



3



F5



ENCURA OUTCAST

SPRUE: Stretch Goals 15

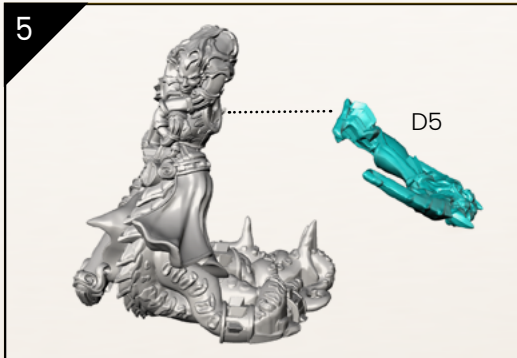
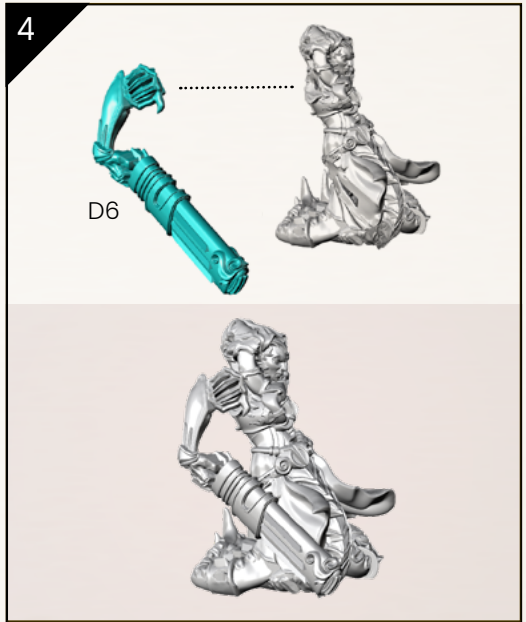
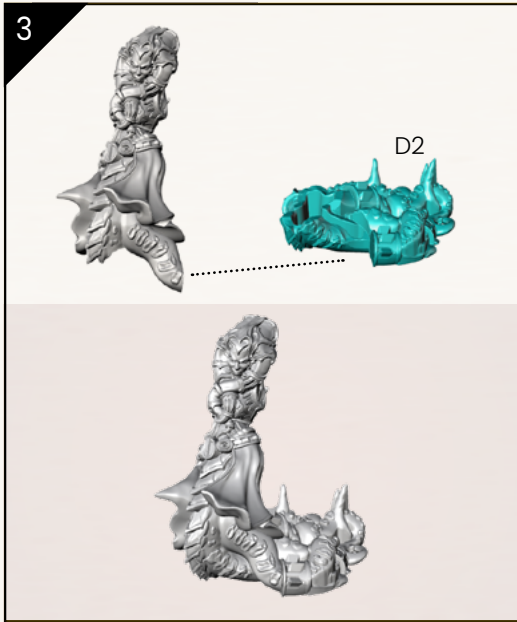
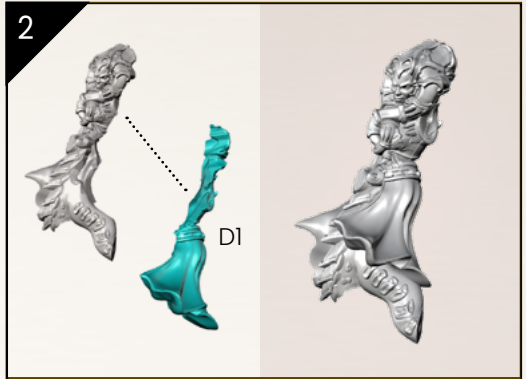
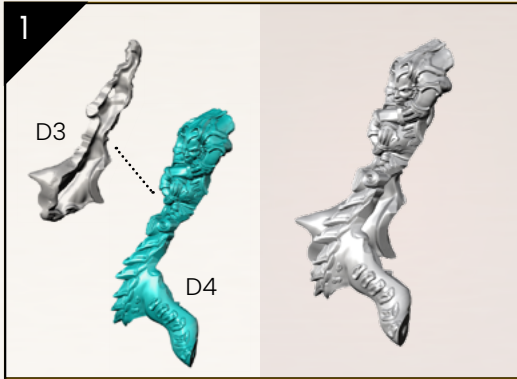

MALICIOUS ANCIENT DRYAD

SPRUE: Stretch Goals 2

1

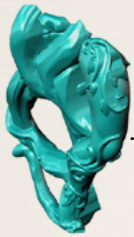

C3



C6

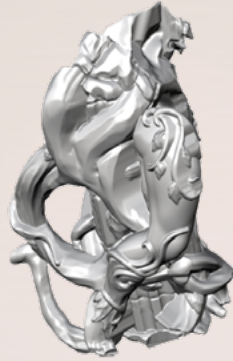

2



C4

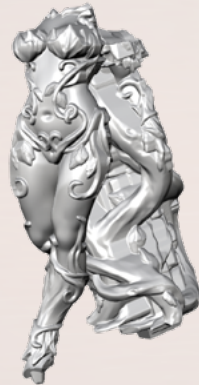
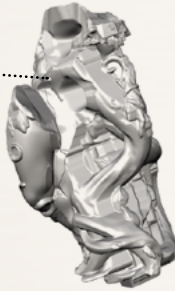

3



C5



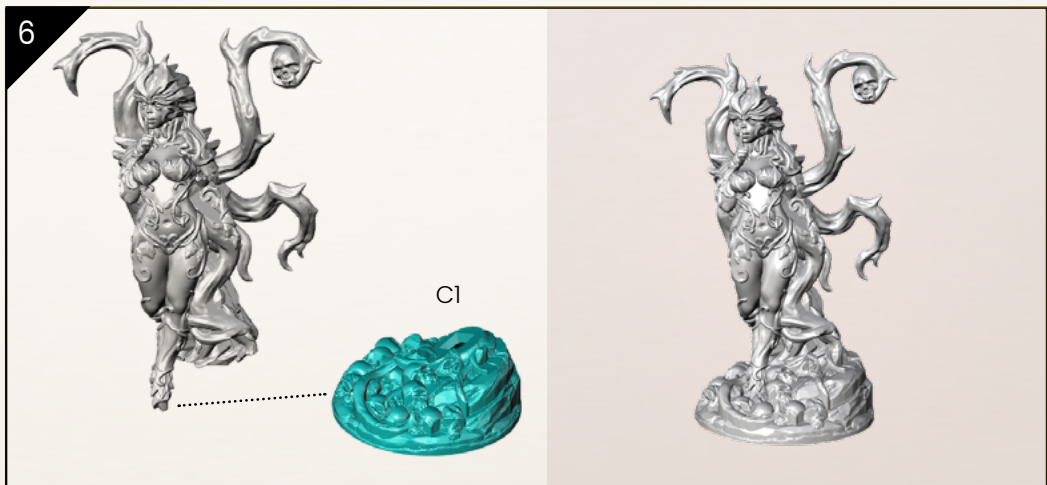
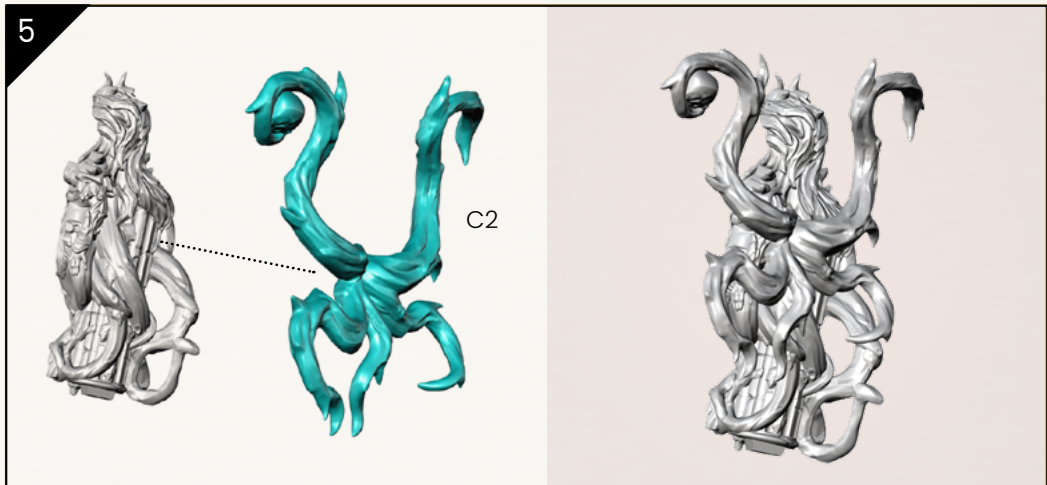
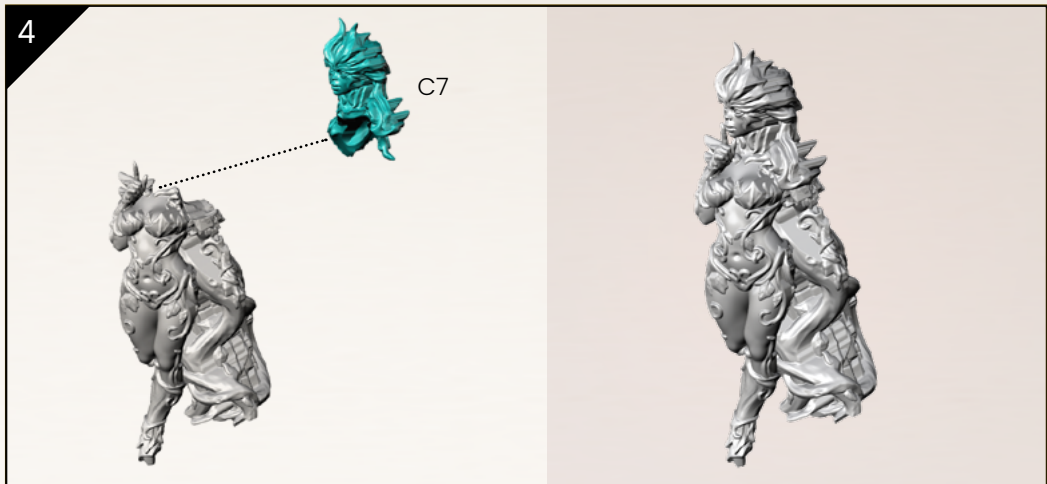

YV'ANDA ARMORED WARRIOR

SPRUE: Stretch Goals I

1

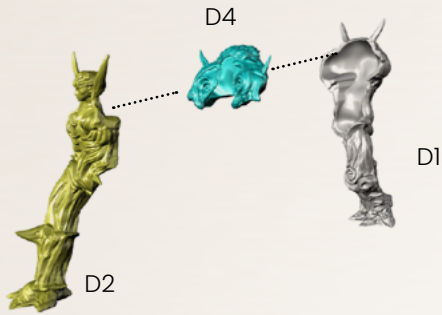

2

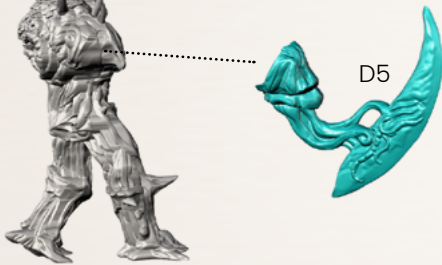

3

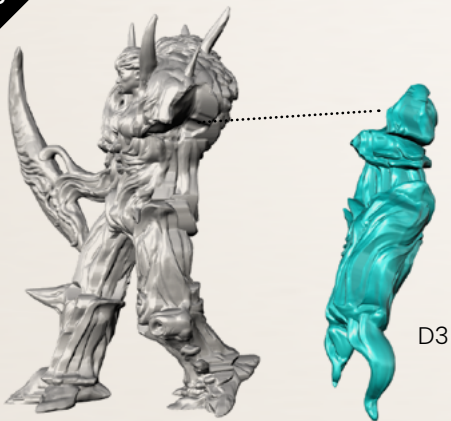

VINDU CASTER

SPRUE: Stretch Goals 14

1

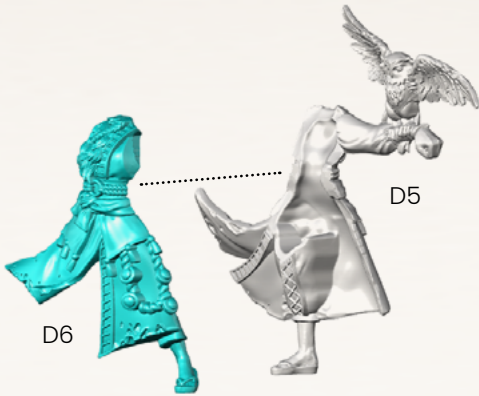

2



3

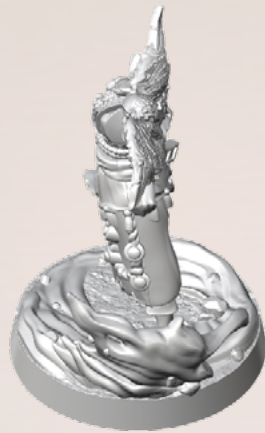
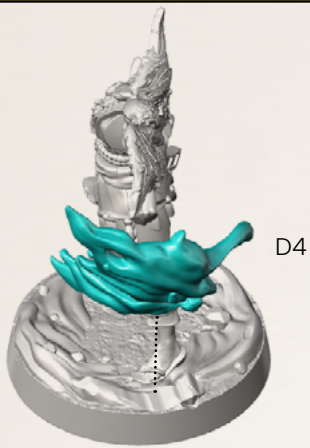

4



5

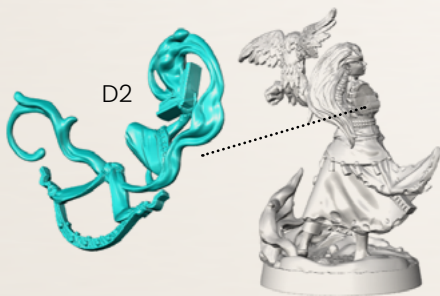

TIDOR THE DWARF CHIEFTAIN

SPRUE: Stretch Goals 8

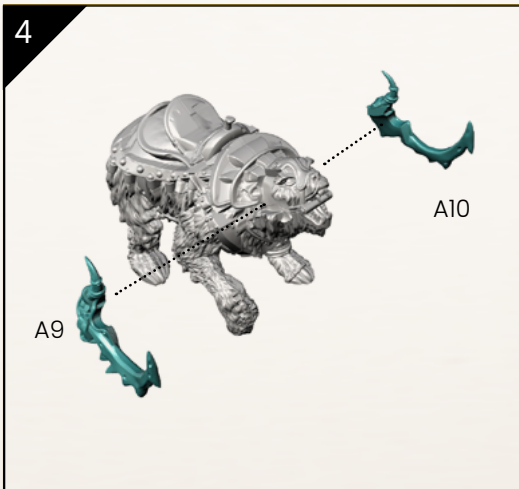
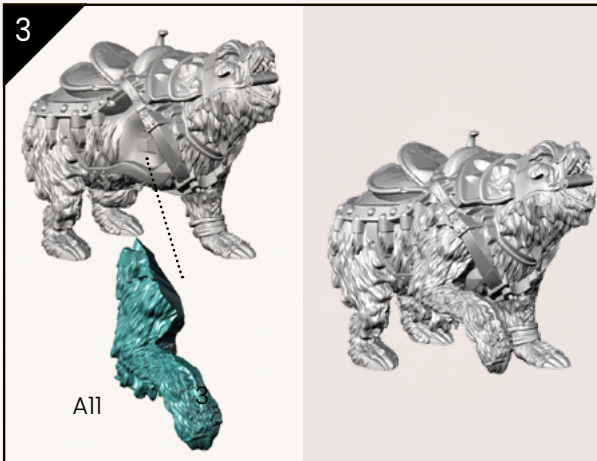
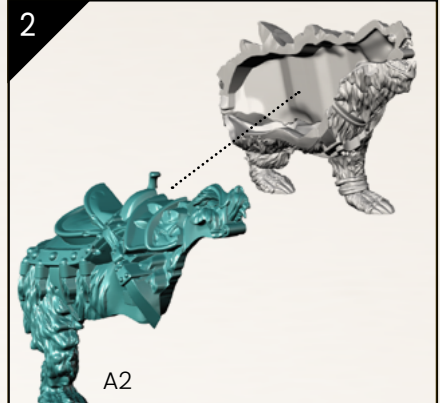
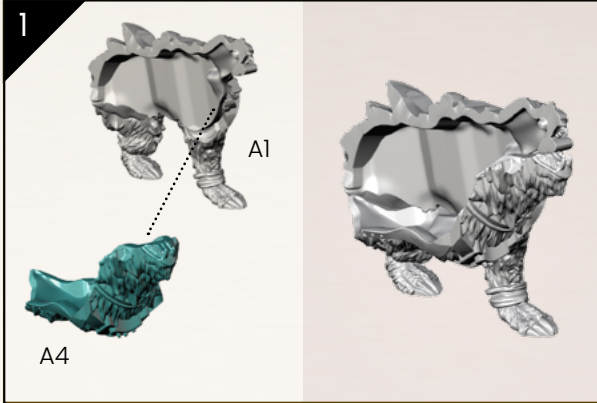

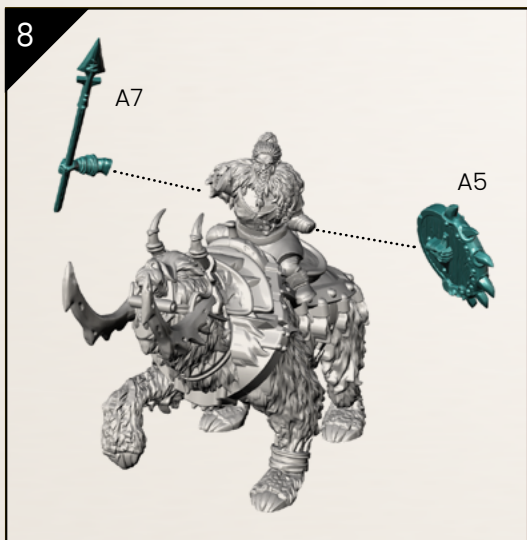
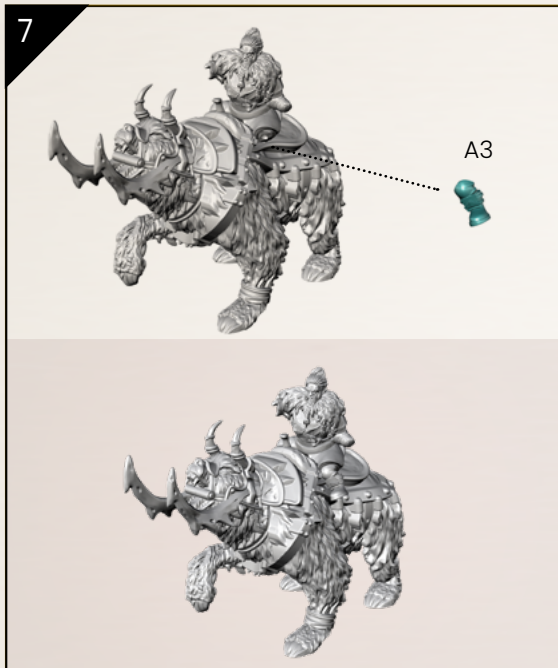
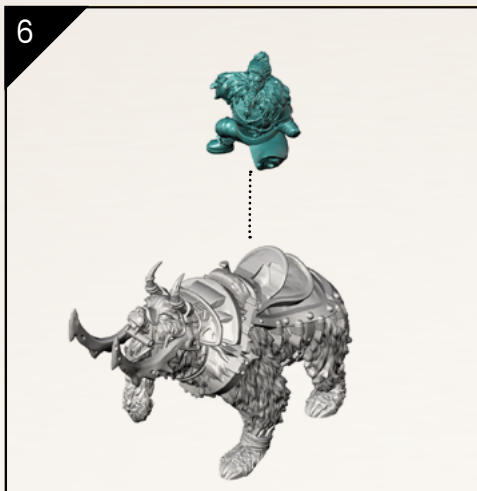
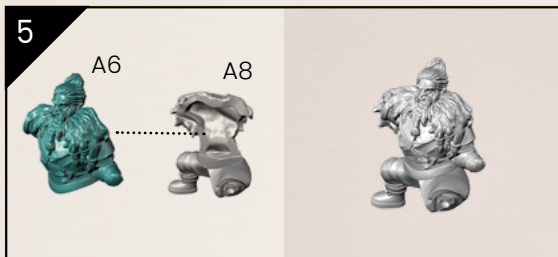

KALA, THE FALLEN QUEEN

SPRUE: Stretch Goals 1

1

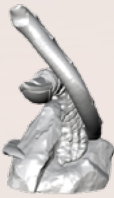
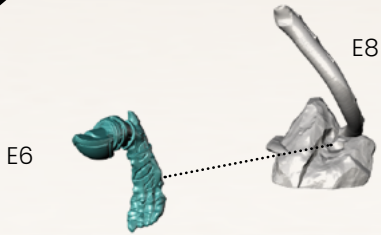

2

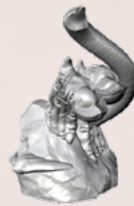
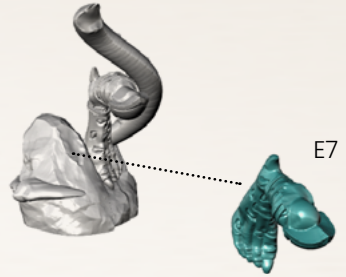

3

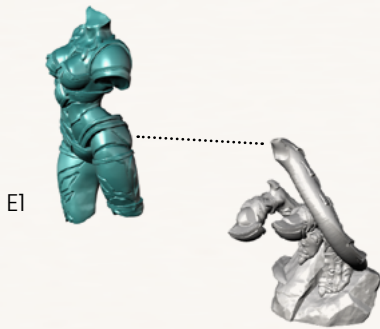

4

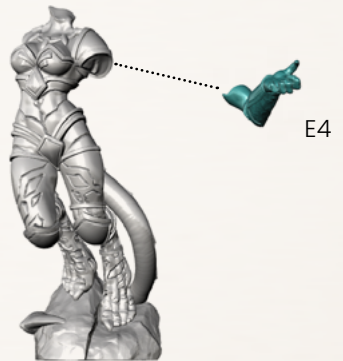

5

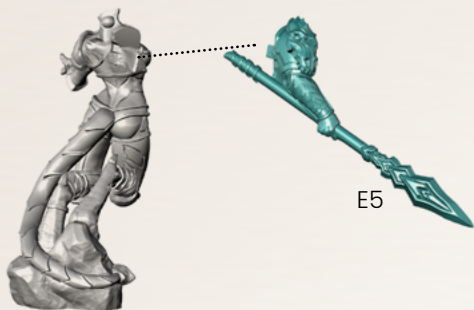

6

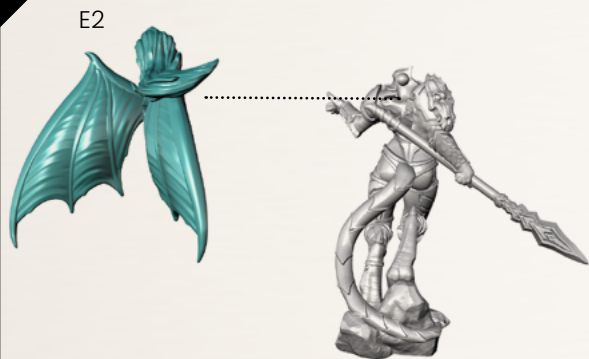

7



NIGHT CRAWLER

SPRUE: Stretch Goals 9

1

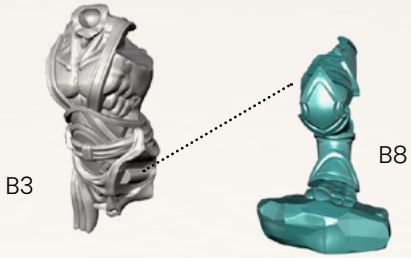

2

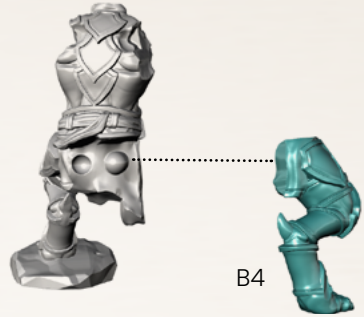

3

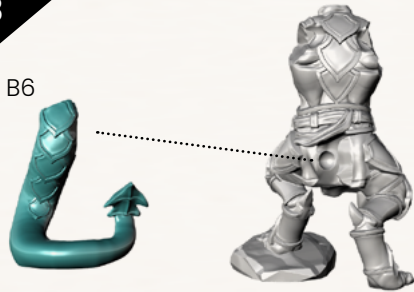

4

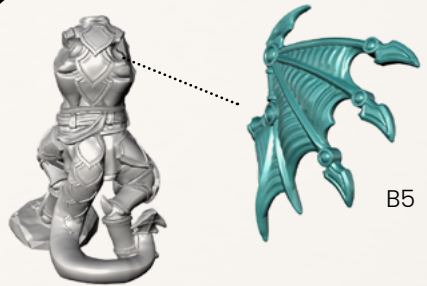

5

B1

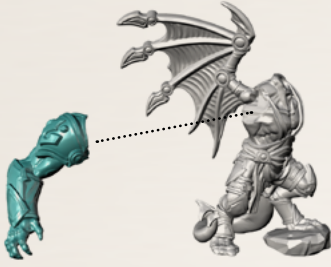

6

B2

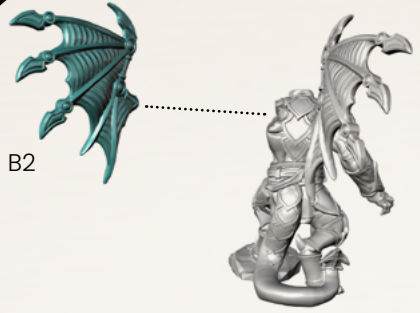

7

B7

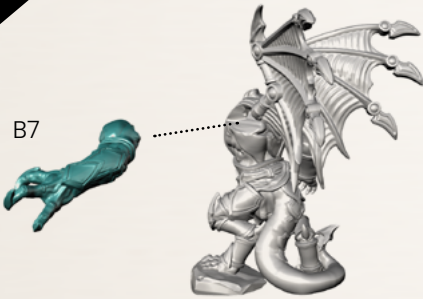

8

B9



ANIMATED GARGOYLE

SPRUE: Stretch Goals 13

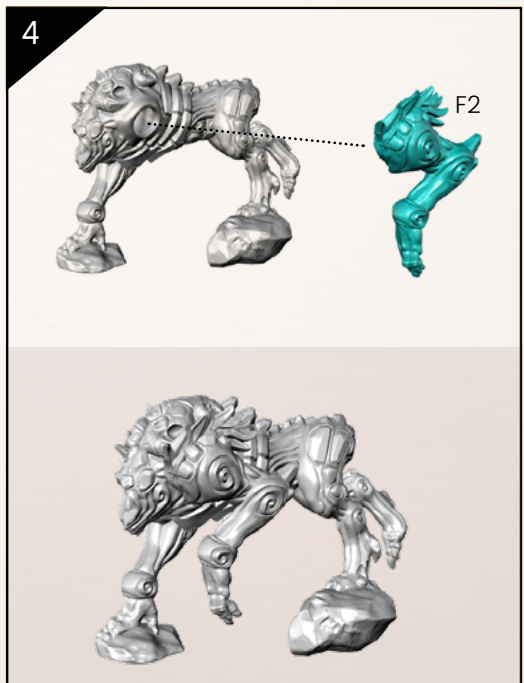
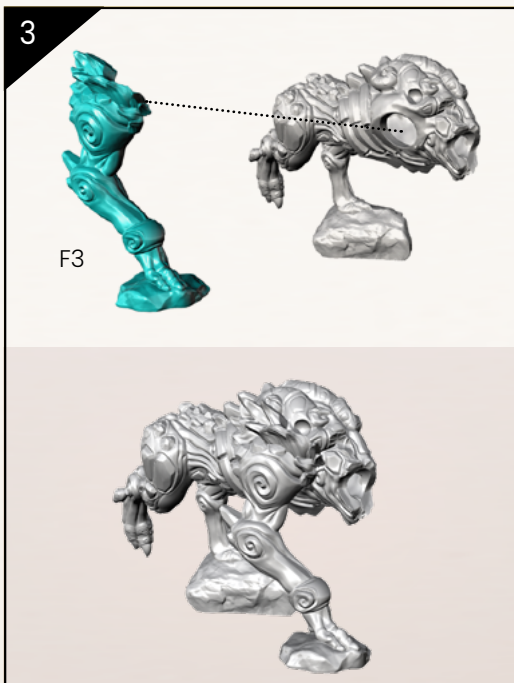
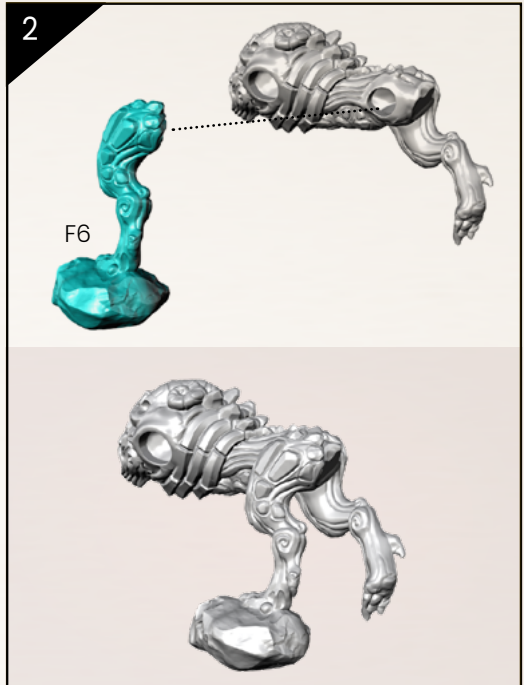
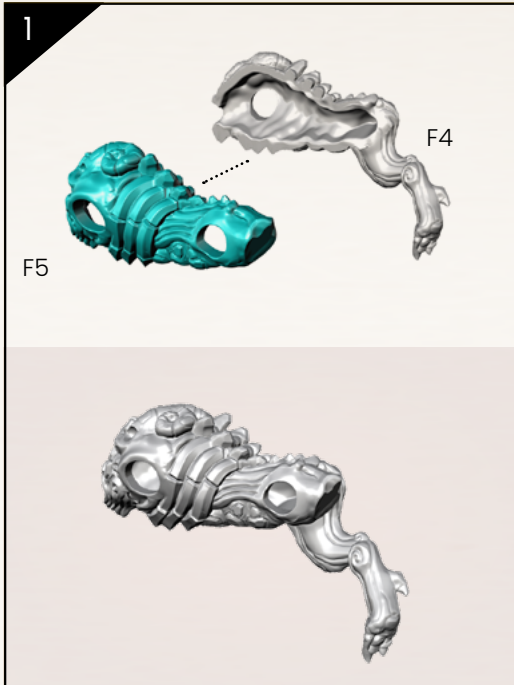

5



F7



6



F1



7



F9



8

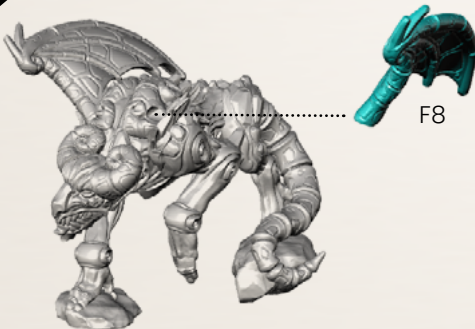

F8



SWARM WARRIOR V1

SPRUE: Stretch Goals 2

1

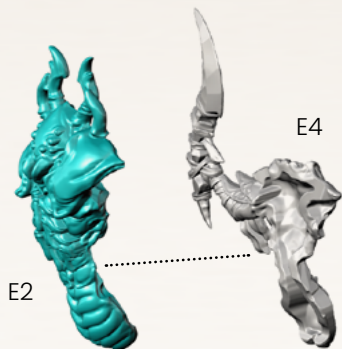

2

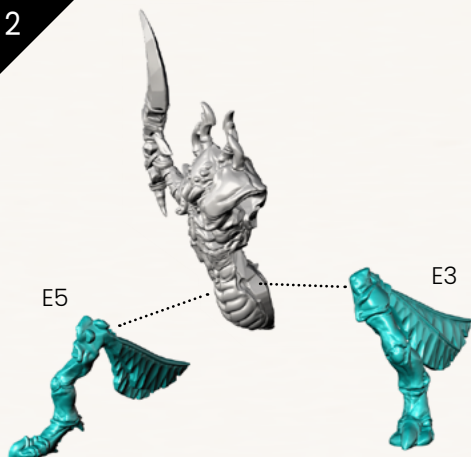

3

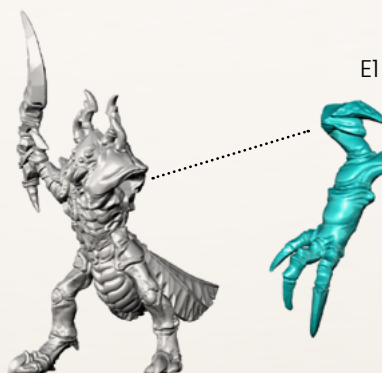

QUEEN OF WINTER

SPRUE: Stretch Goals 14

1

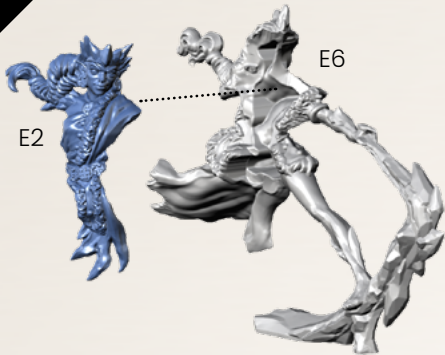

2

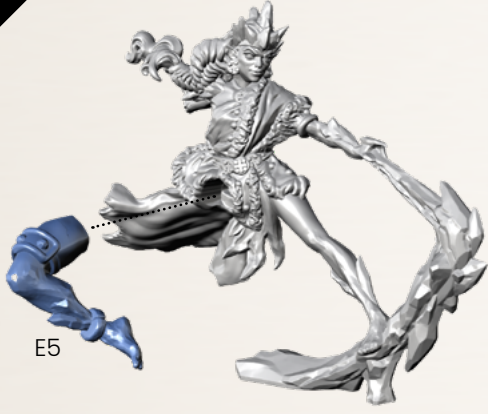

3

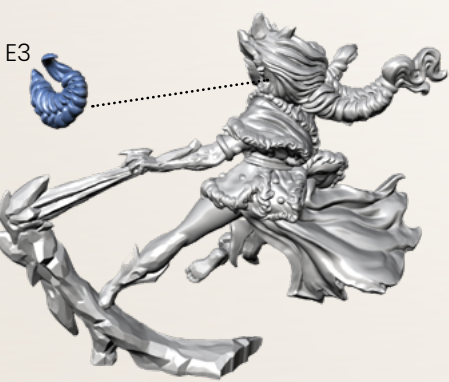

4

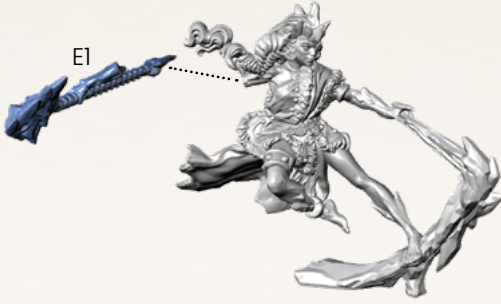

5

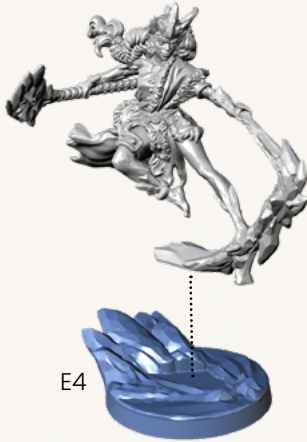

PROPHET OF CHAOS

SPRUE: Stretch Goals 5

1

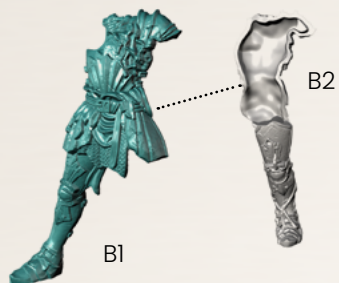

2

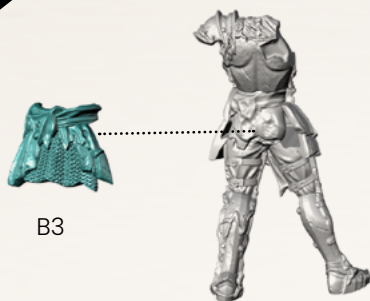

3

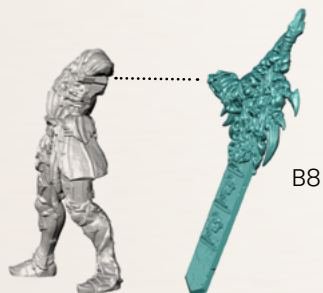

4

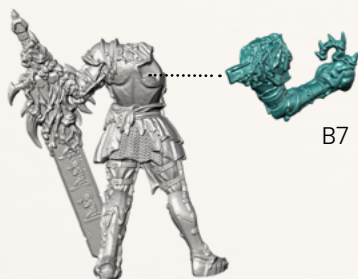

5



6



7



BISHOP OF ELISHU

SPRUE: Stretch Goals 9

1

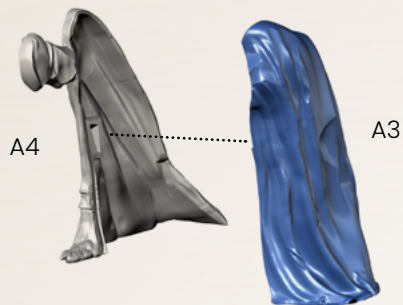

2

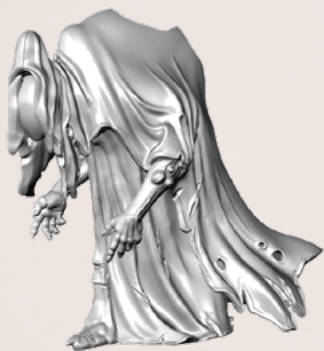
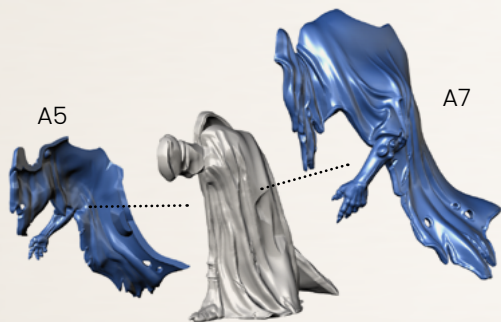

3

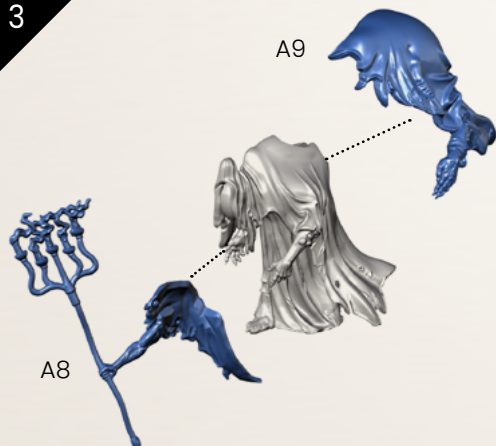

4

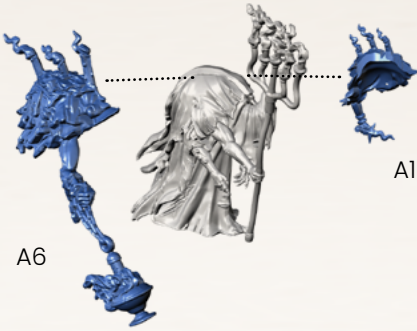

5

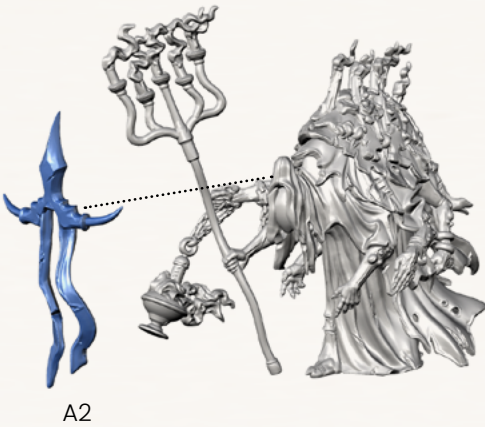

DEVOURER OF SANITY

SPRUE: Stretch Goals 15

1

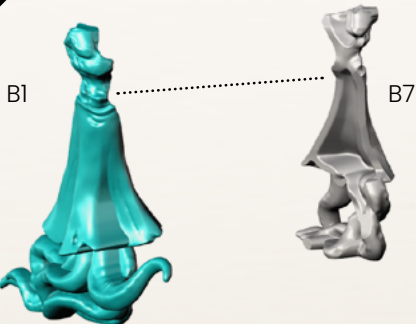

2



B5

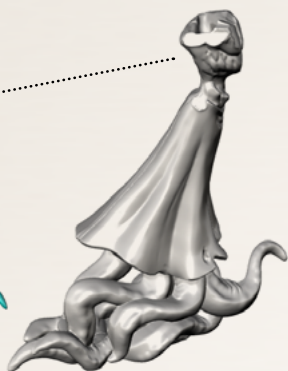

3

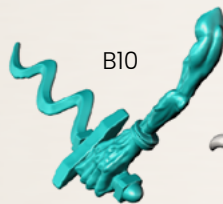

B10

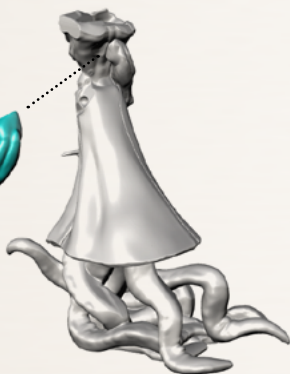

4



B9

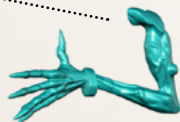

B11

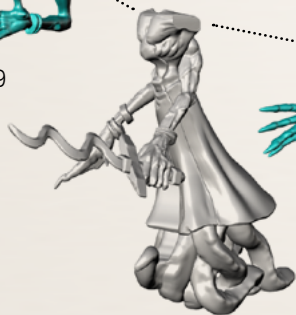

5

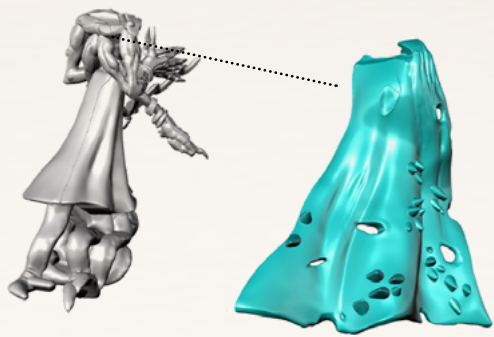

B4



6

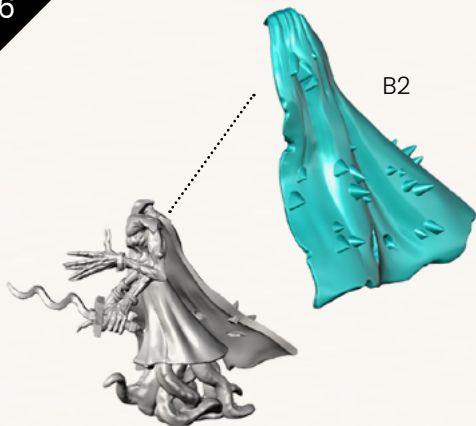

B2

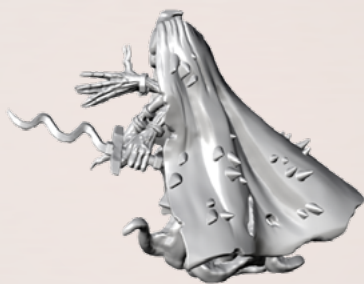

7

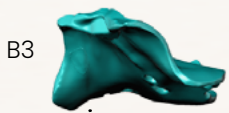

B3



8

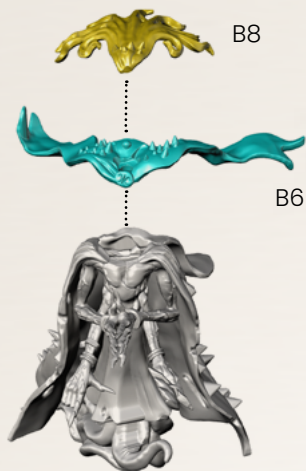

9

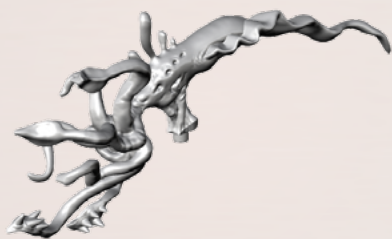
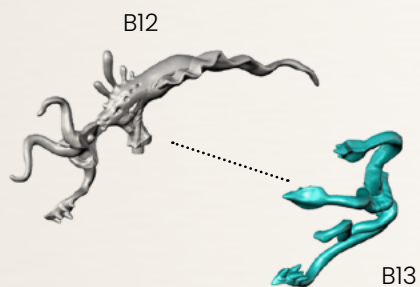

10



POSSESSED MASS OF FLESH

SPRUE: Stretch Goals 12

1

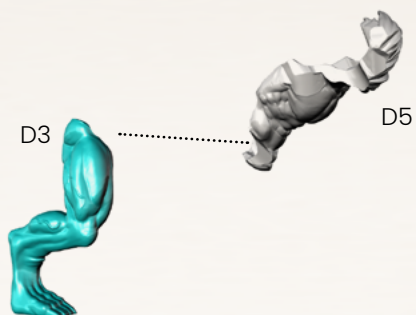

2

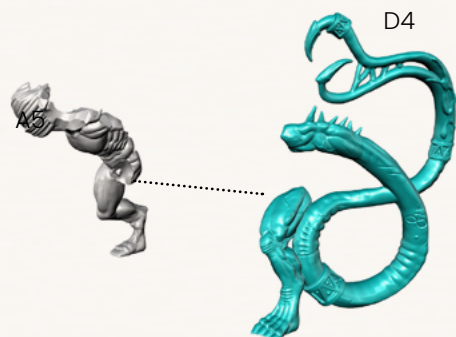

3



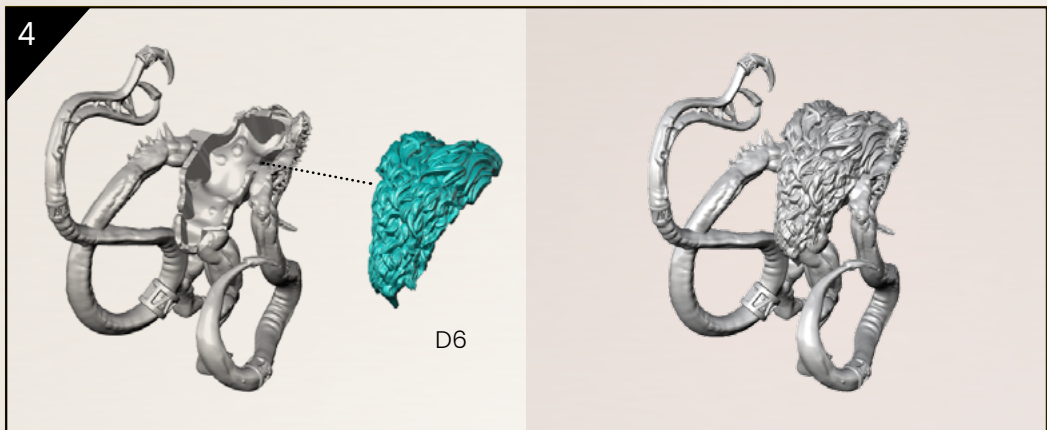

SHAMBLING MOUND

SPRUE: Stretch Goals 13

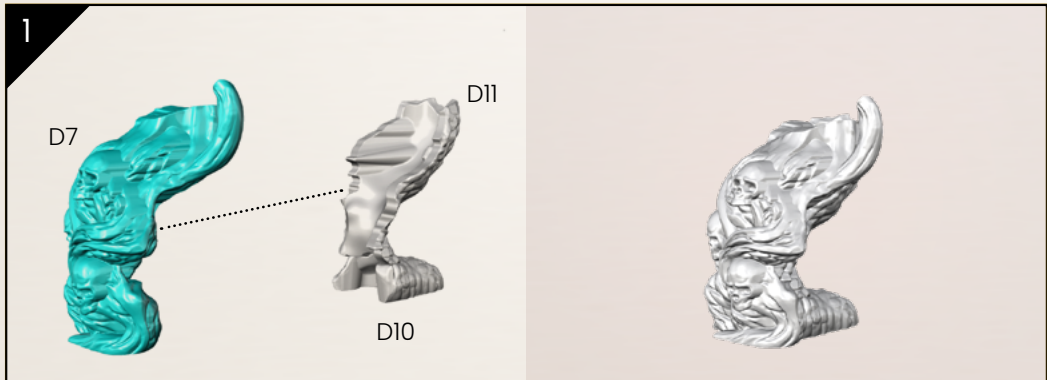

2

D6

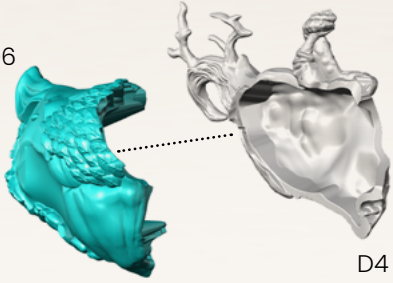

D4

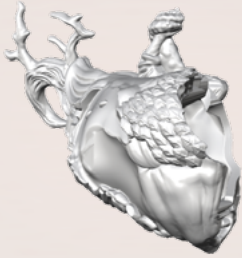

3

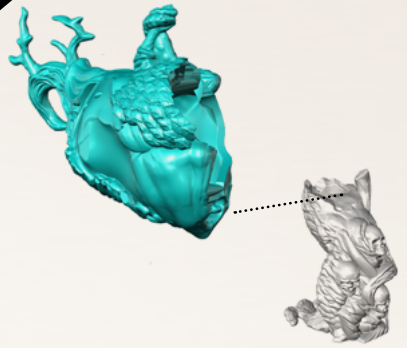

4

D5

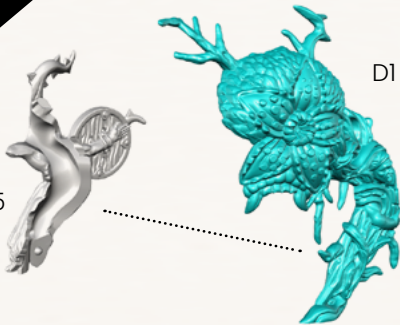

D1



5

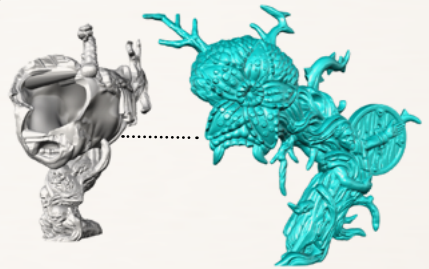

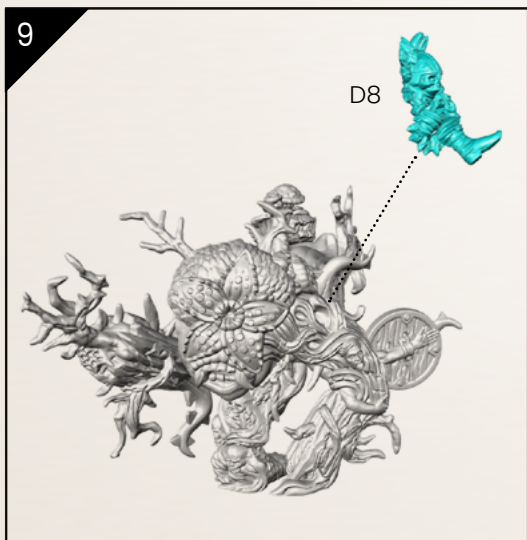
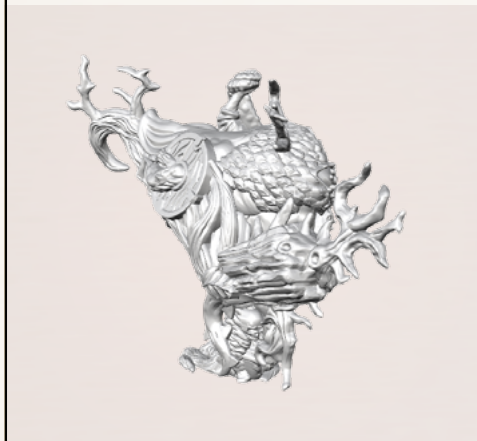
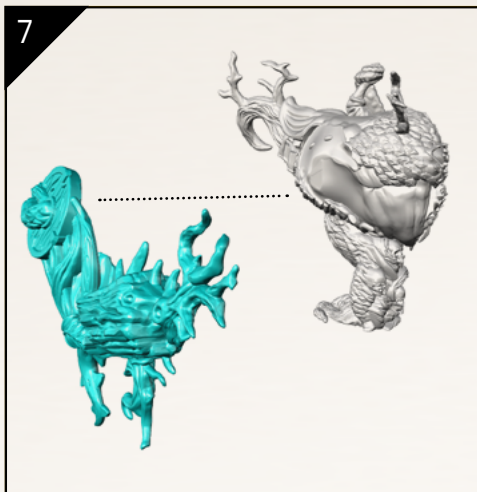

BASILISK

SPRUE: Stretch Goals 15

1

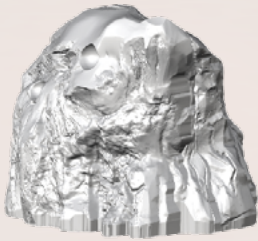
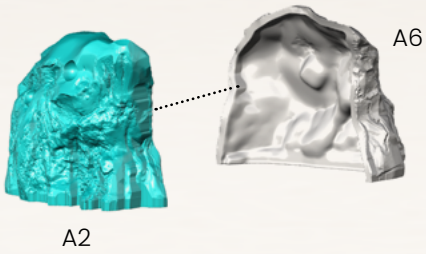

2

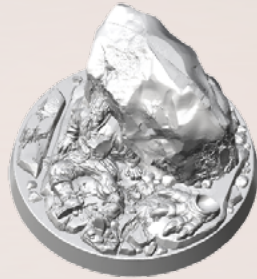
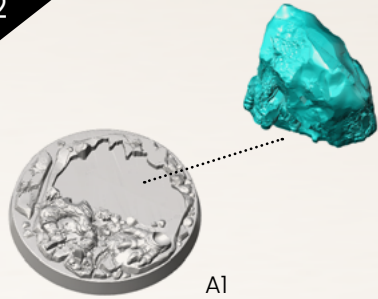

3

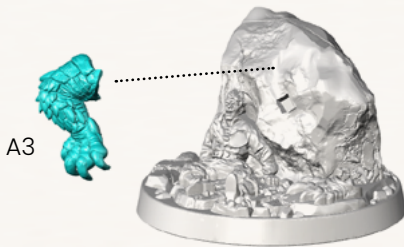

4

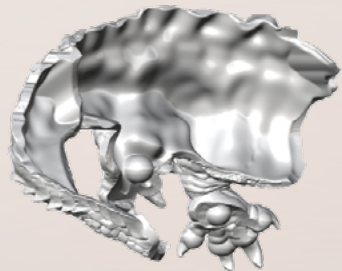
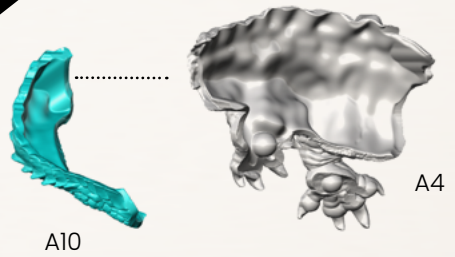

5

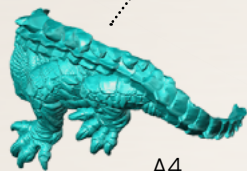
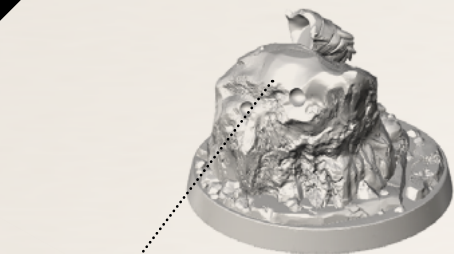

A4



6

A9

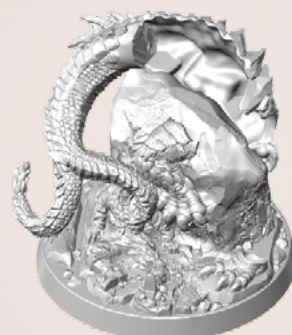
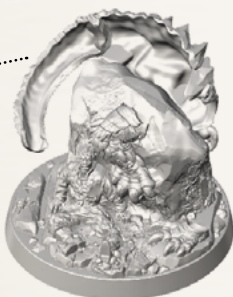

7

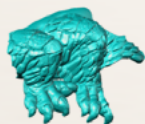
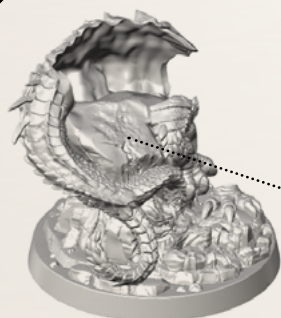

A5

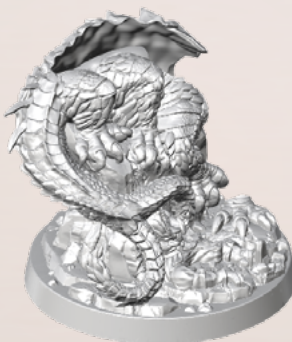

8

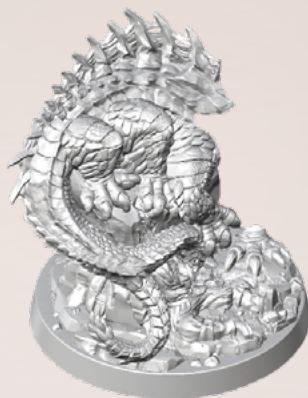

9



10

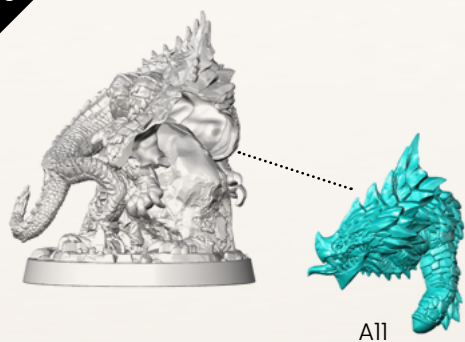

WARUNAS OUTCAST

SPRUE: Stretch Goals 10

1

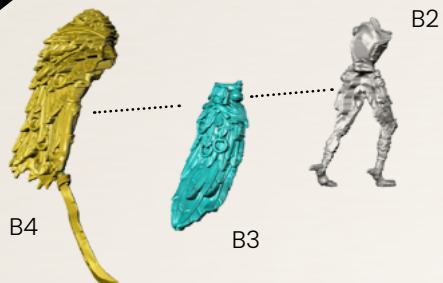

2

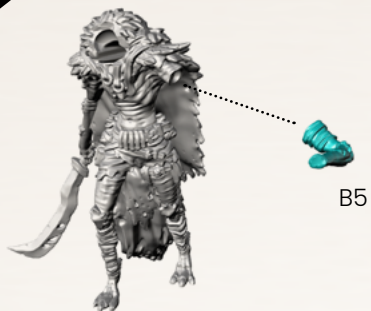

3

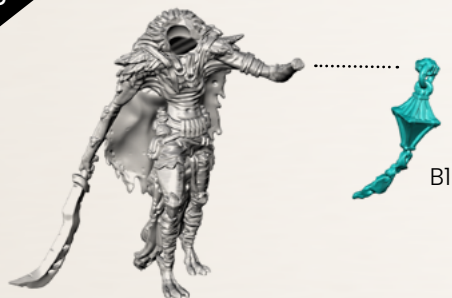

4

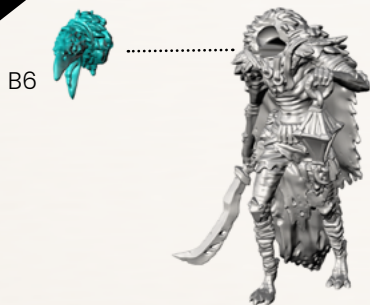

CORDYCEP MIND TAKER (WITH AN OPTIONAL HEAD)

SPRUE: Stretch Goals 12

1

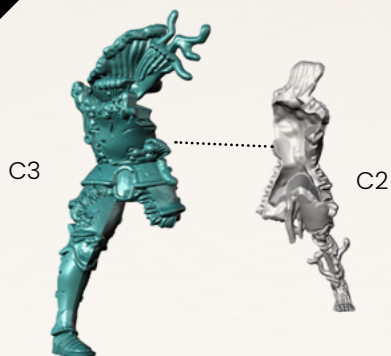

2

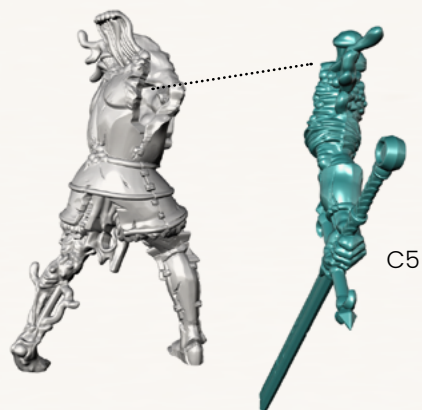

3

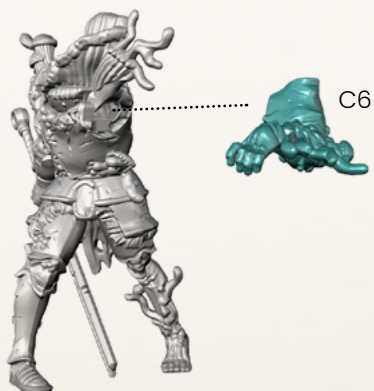

4



5



DISPLACED BEAST

SPRUE: Stretch Goals 12

1

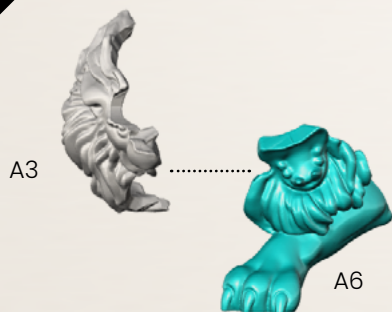

2



A5



3

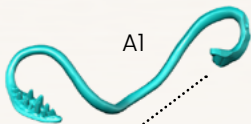

A1



4

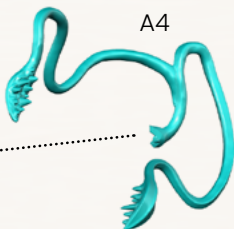

A4

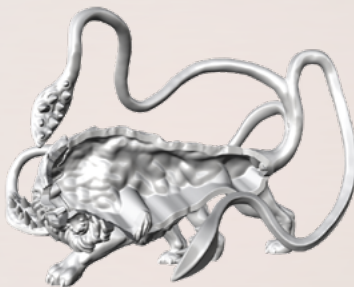

5



A2



XORN MONSTROSITY

SPRUE: Stretch Goals 10

1

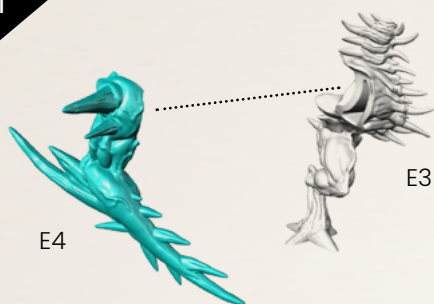

2

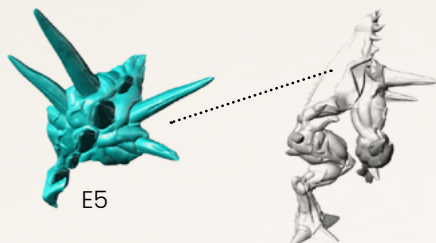

3

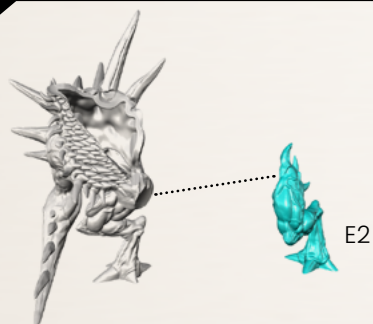

4

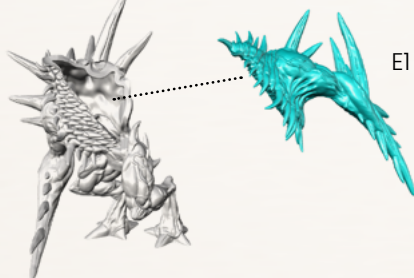

MURDEROUS CUBE

SPRUE: Stretch Goals 14

1

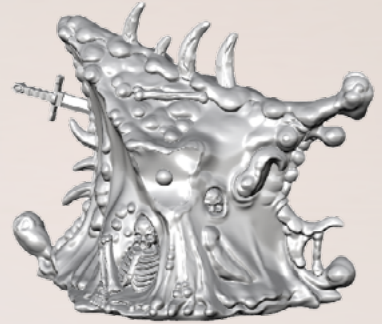
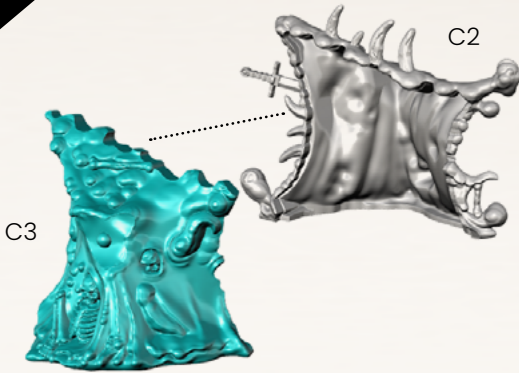

2

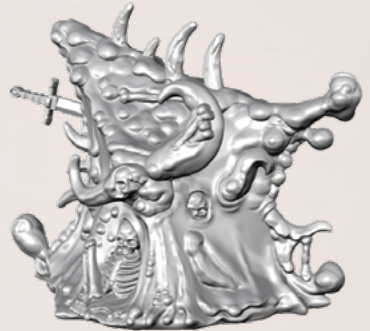
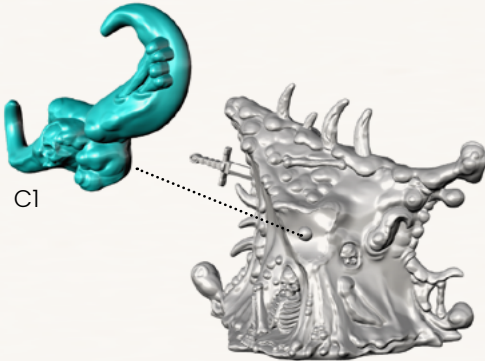

STANDARD CLOCK

SPRUE: Stretch Goals 10

1

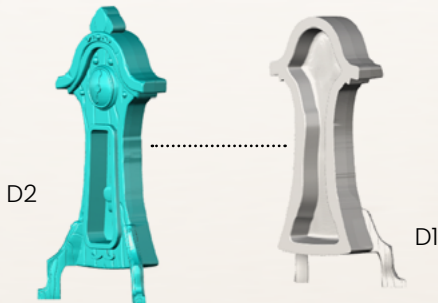

MIMIC CLOCK

SPRUE: Stretch Goals 10

1

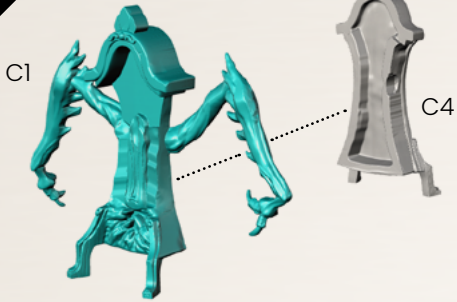

2

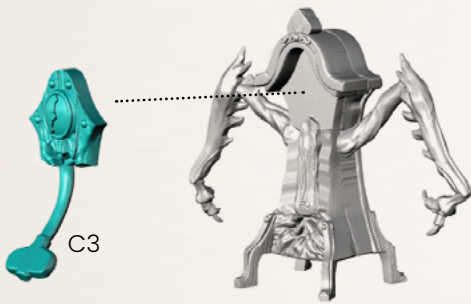

3

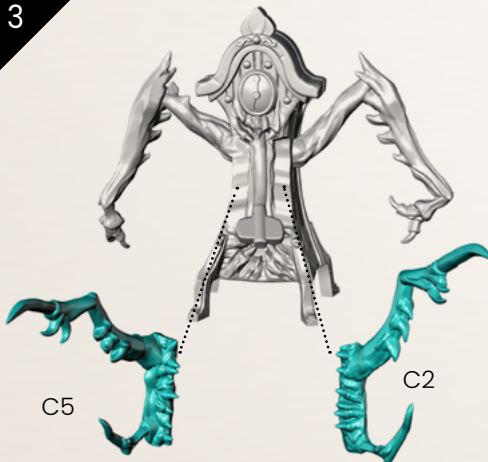

YETI (WITH TWO PAIRS OF OPTIONAL HORNS)

SPRUE: Stretch Goals 6

1

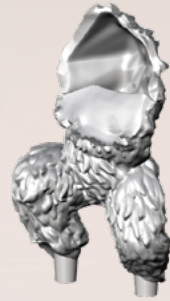
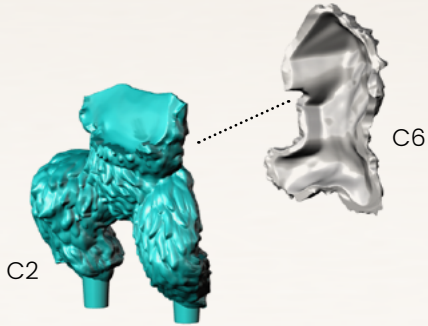

2

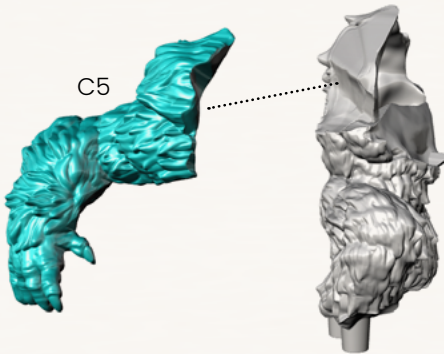

3

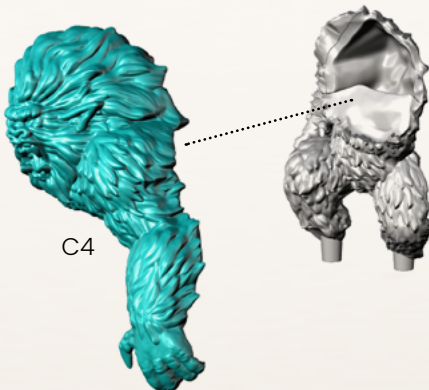

4



C1



5

YETI: Optional horns A



C3

C8



5

YETI: Optional horns B



C9

C7



TROLL

SPRUE: Stretch Goals 8

1

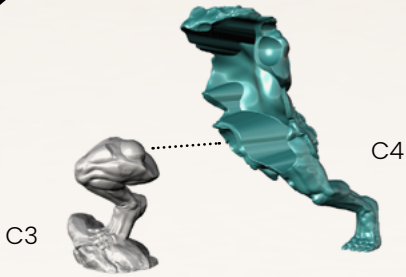

2

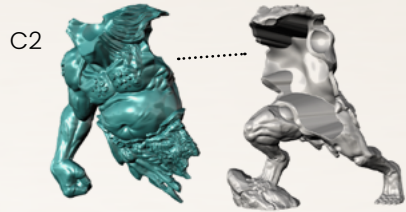

3

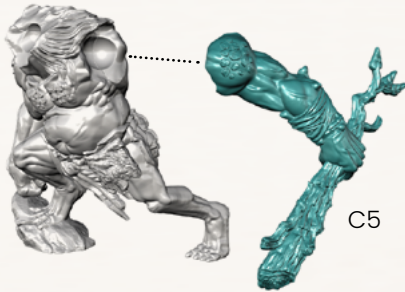

4

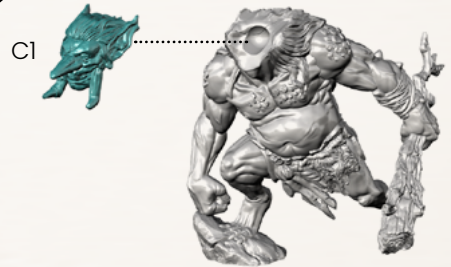

SCARECROW (WITH OPTIONAL PROPS)

SPRUE: Stretch Goals 8

1

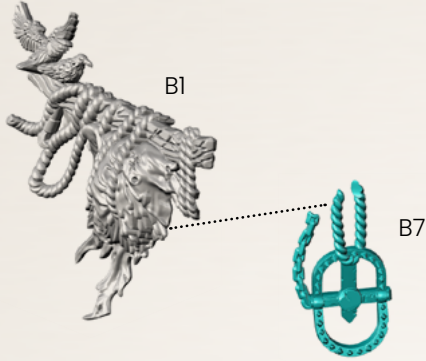

2

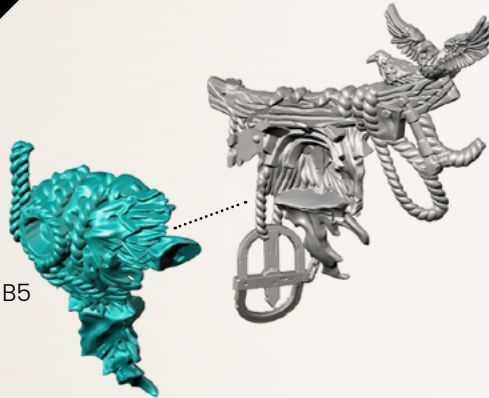

3

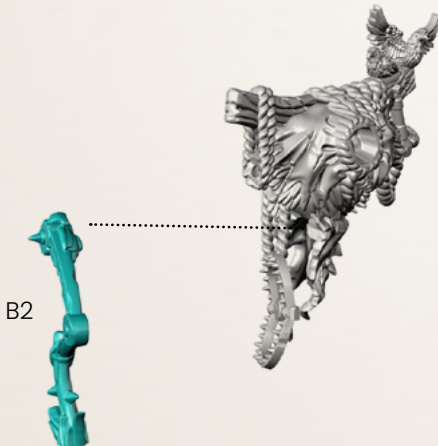

4

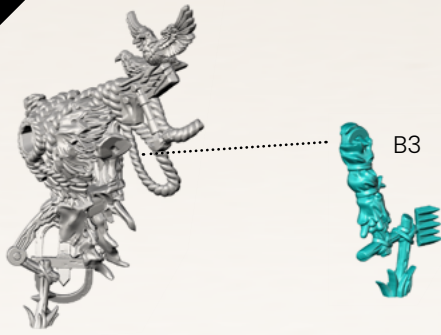

5

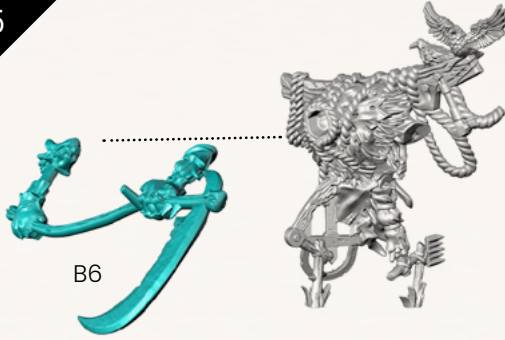

6

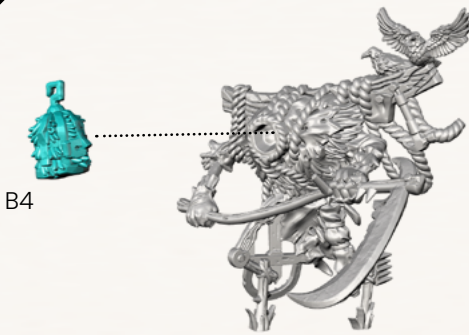

7

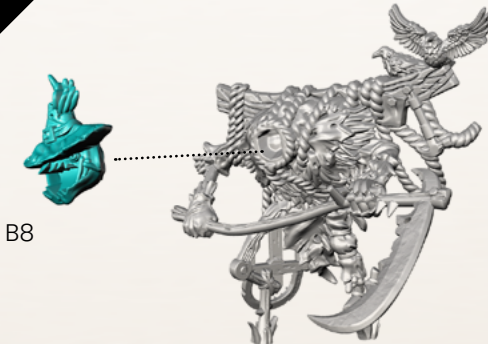

BEAR FROM THE DEEP

SPRUE: Stretch Goals 9

1

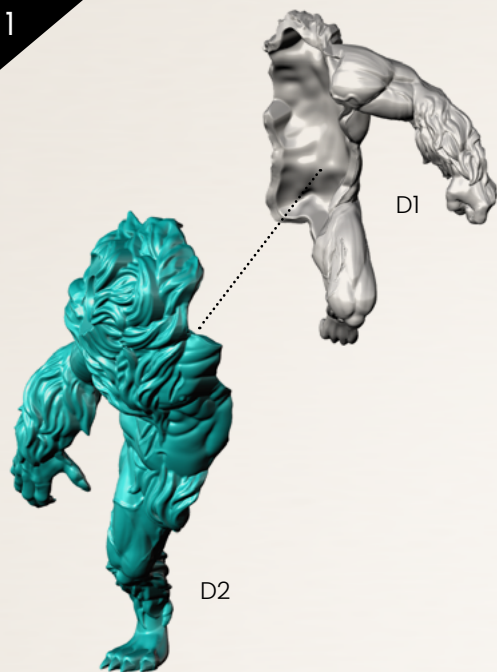

2

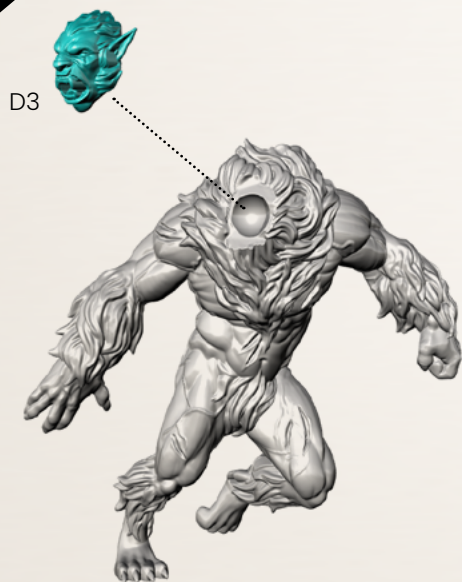

BRAIN SQUID

SPRUE: Stretch Goals 16

1

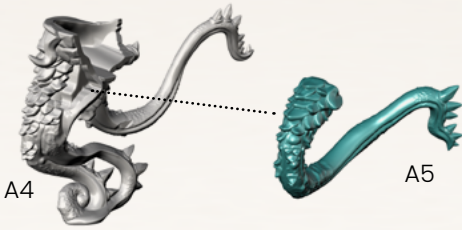

2

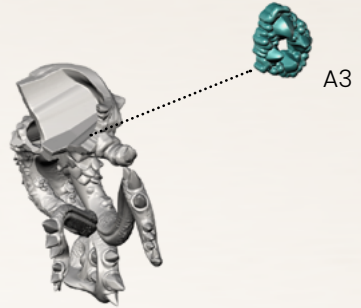

3

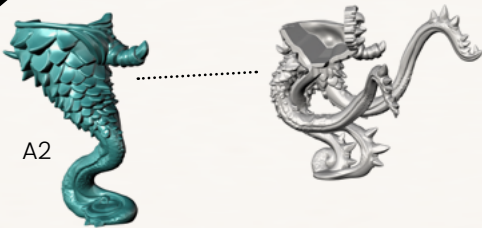

4

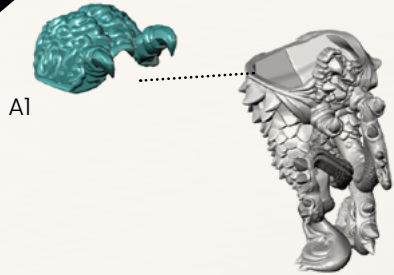

OGRE

SPRUE: Stretch Goals 2, Stretch Goals 6, Stretch Goals 13

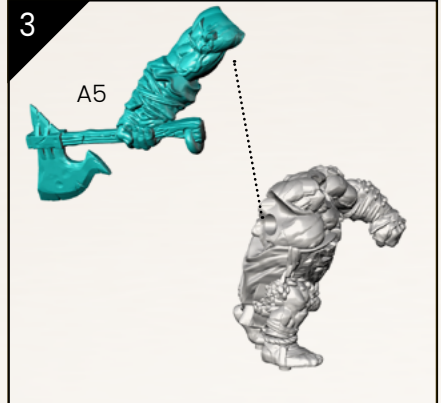
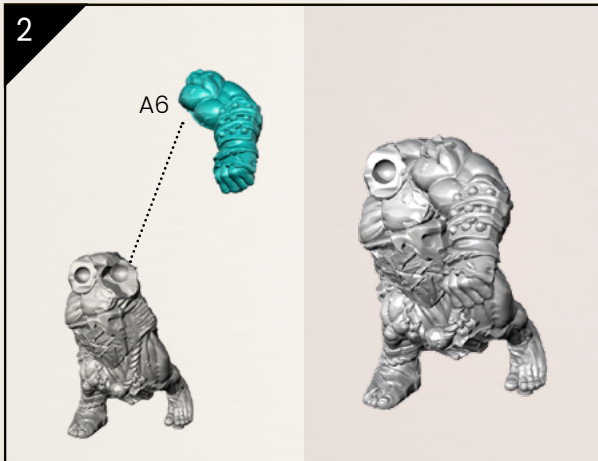
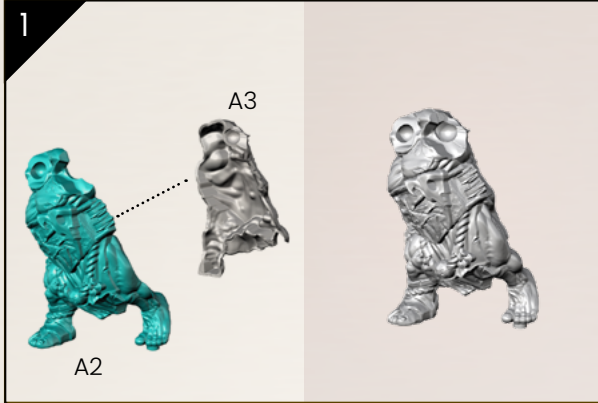

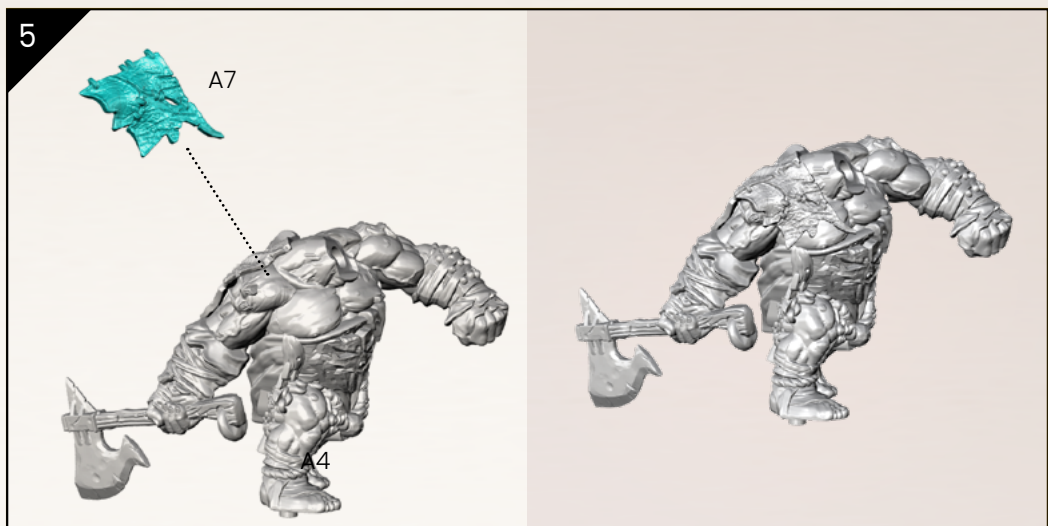

SKULL MAGUS

SPRUE: Stretch Goals 14

1

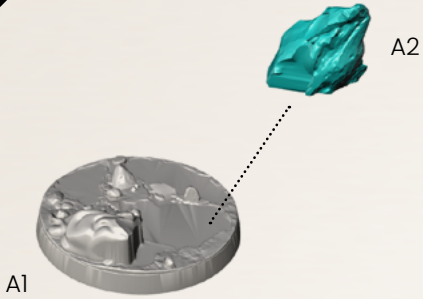

2

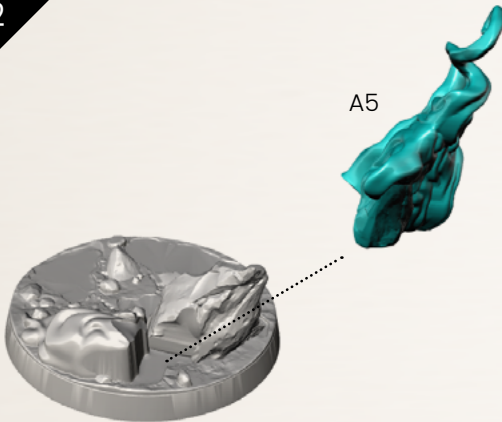

3

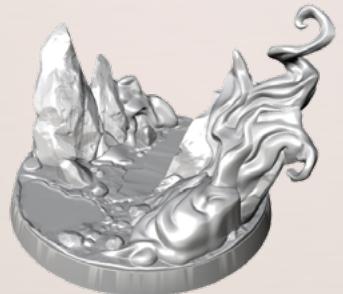
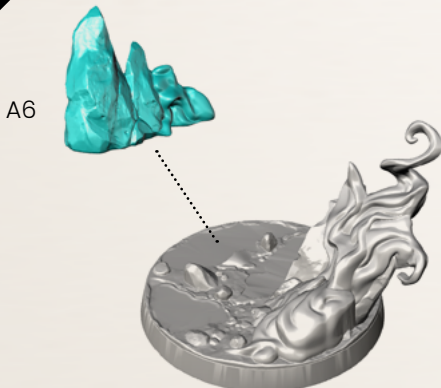

4

A3

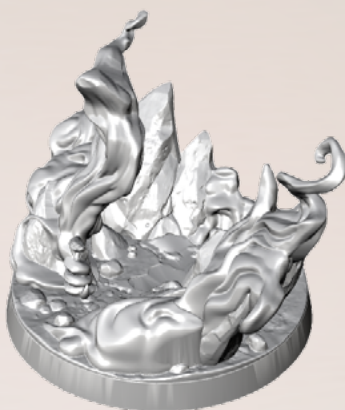
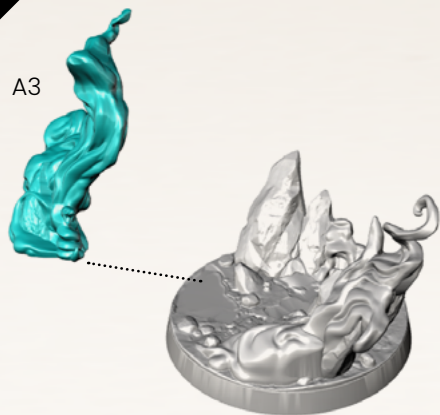

5

A8

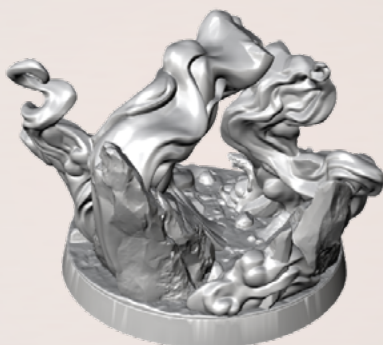
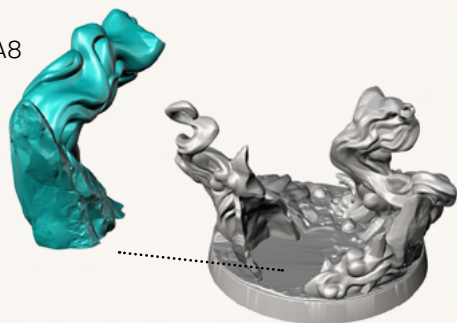

6

A7

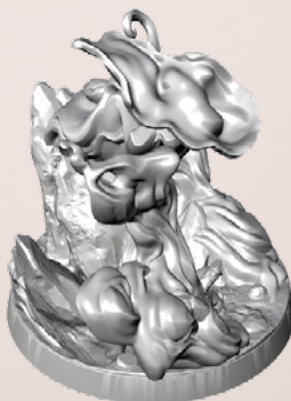
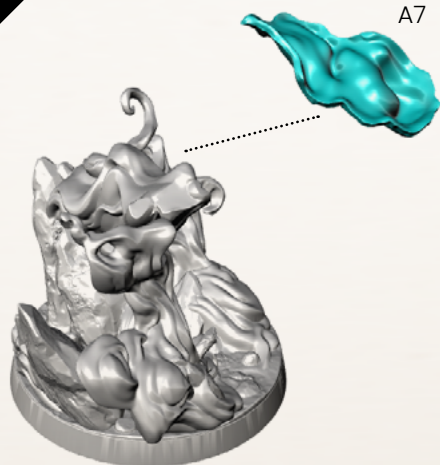

7

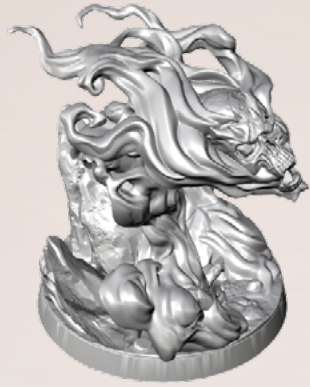
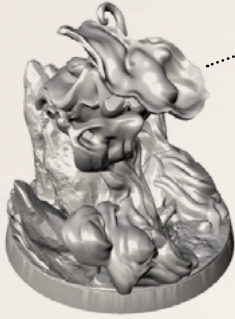
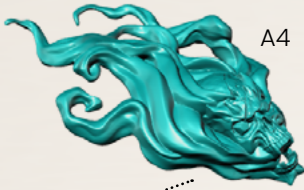

KOBOLD

SPRUE: Stretch Goals 2

1

D3



D2



2

D1



DOPPLEGANGER

SPRUE: Stretch Goals 2

1

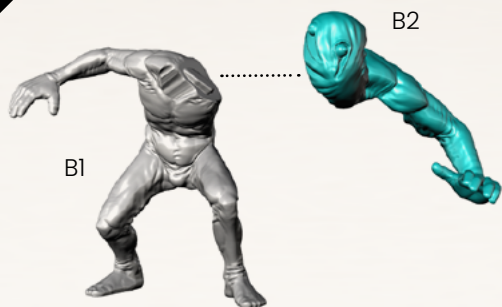

BANSHEE

SPRUE: Stretch Goals 14

1

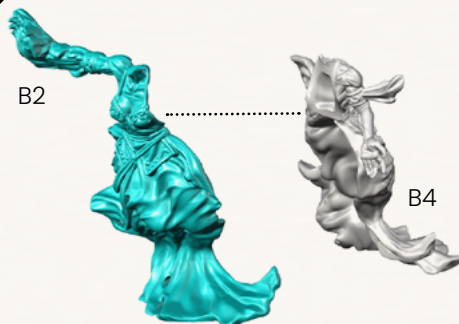

2

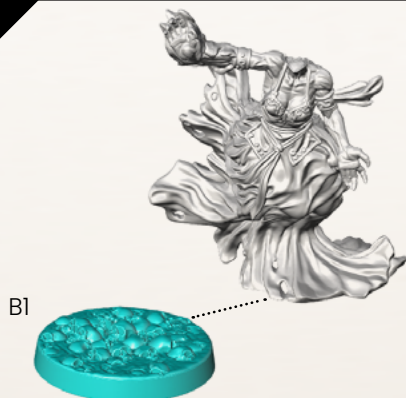

3



KRAKEN'S TENTACLES

SPRUE: Stretch Goals 13

1



2



THREE KOBOLDS IN A TRENCH COAT

SPRUE: Stretch Goals 15

1

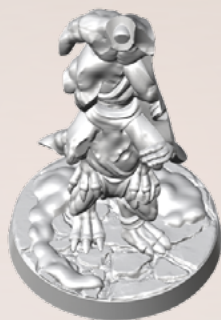
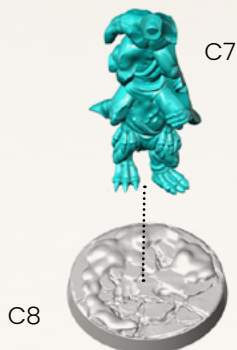

2

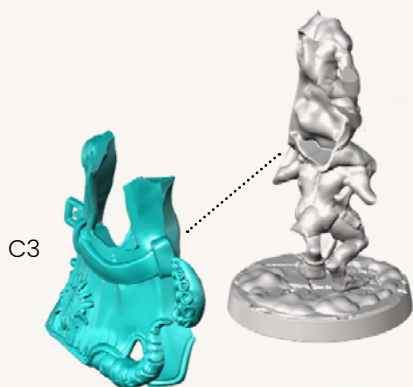

3

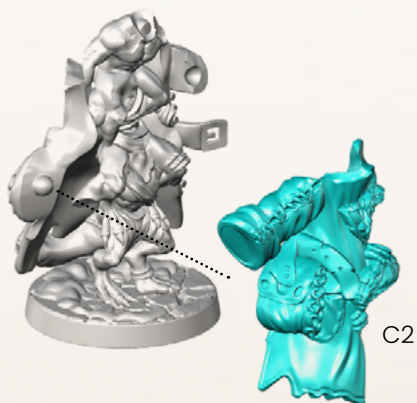

4

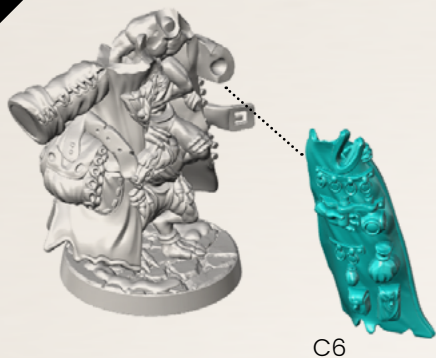

5

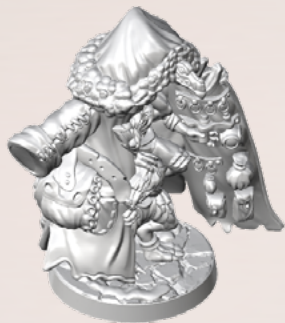
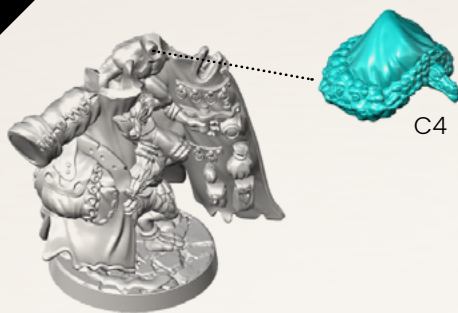

6

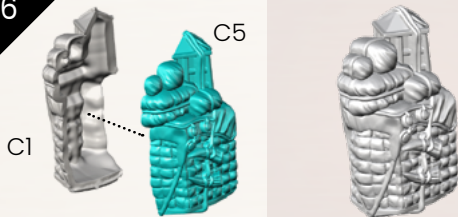

7

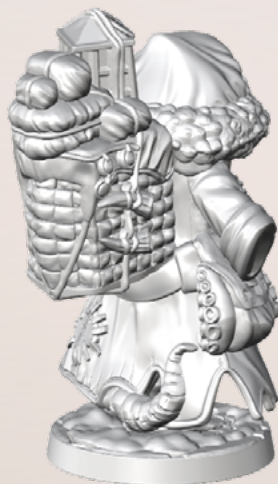
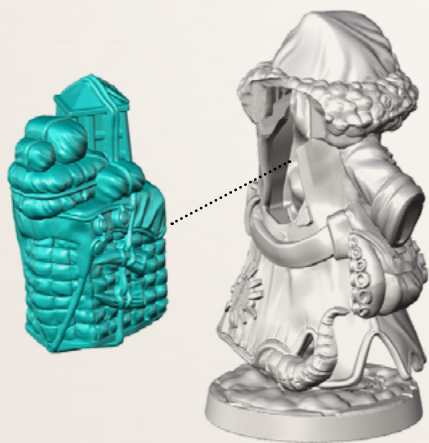

ROBLIN THE GOBLIN

SPRUE: Stretch Goals 16

Roblin the Goblin: Pose A

1

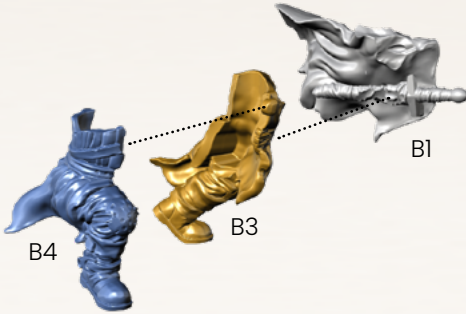

2

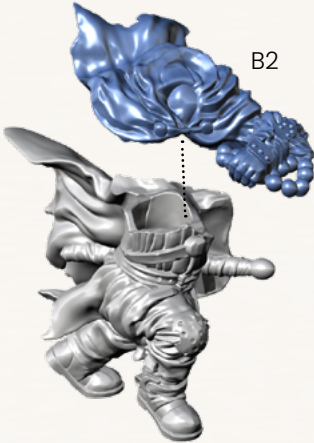

3

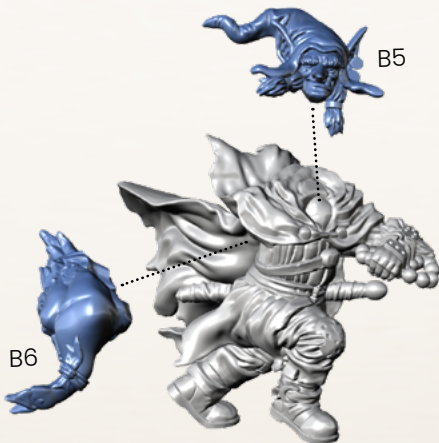

1

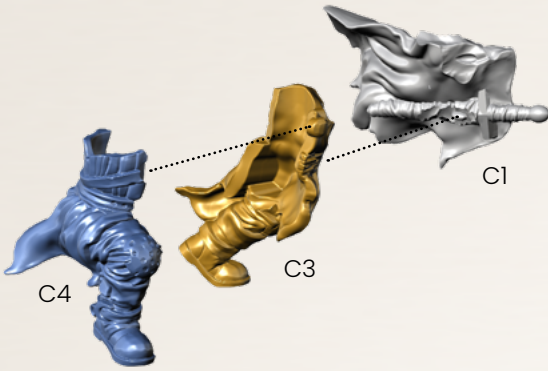

2

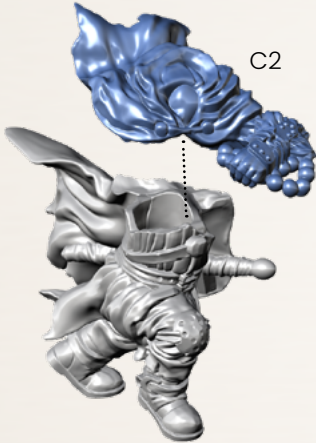

3

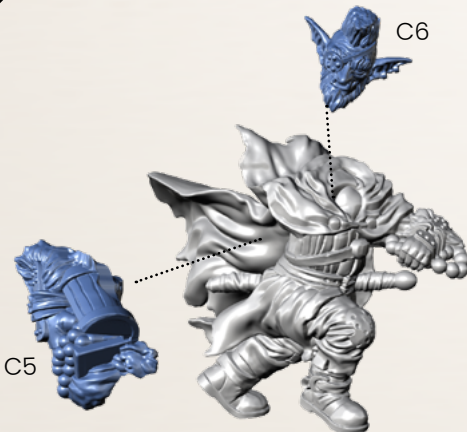

HAND OF STEEL THE CONSTRUCT

SPRUE: Stretch Goals 10

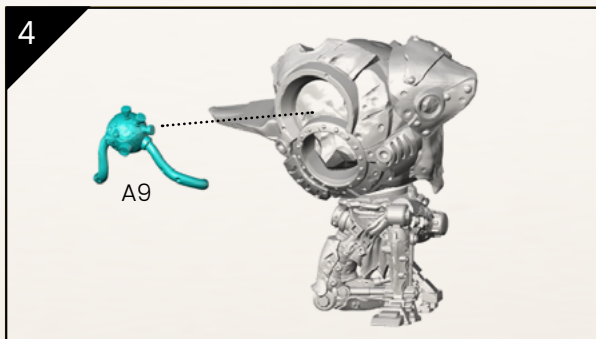
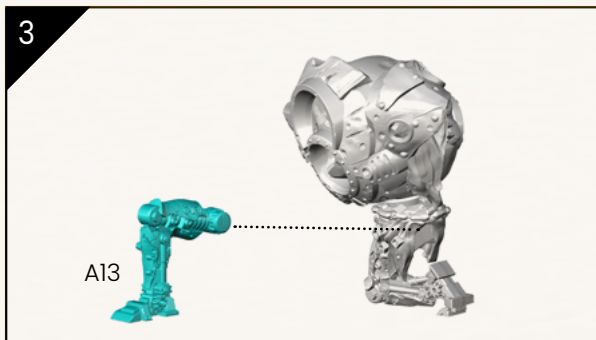
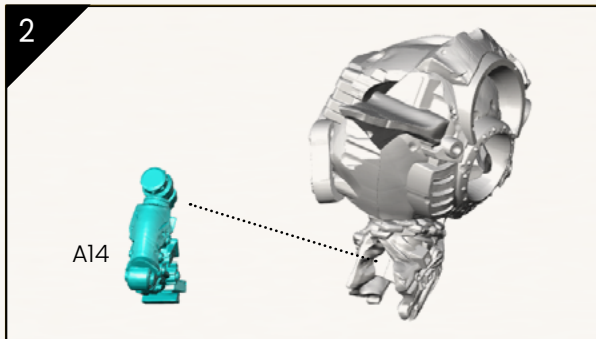
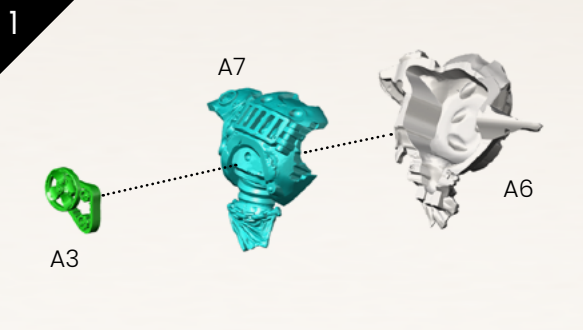

5

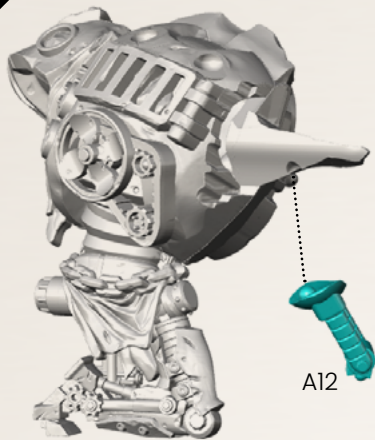

A12

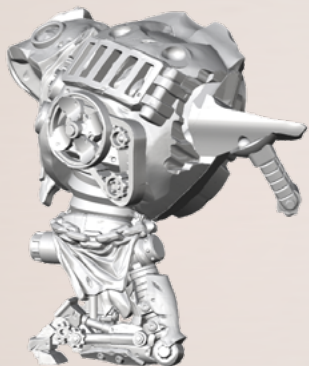

6

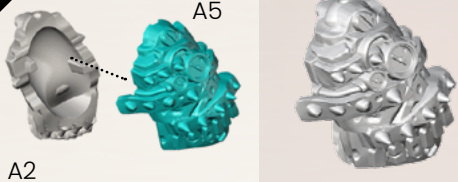

A5

A2

7

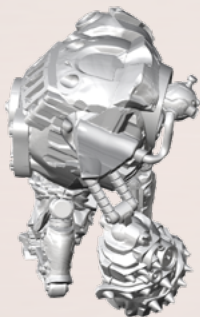
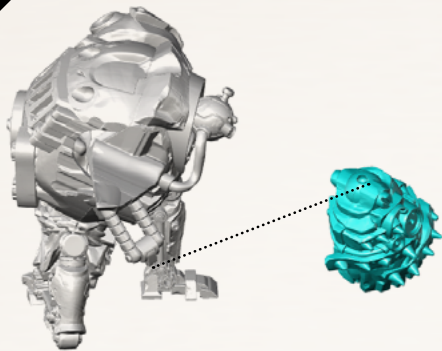

8

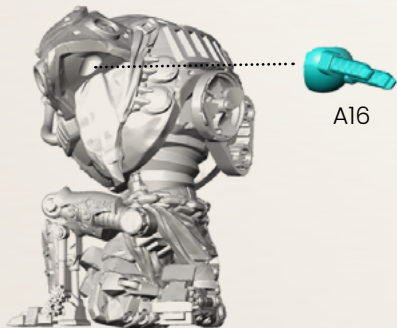

A16



9

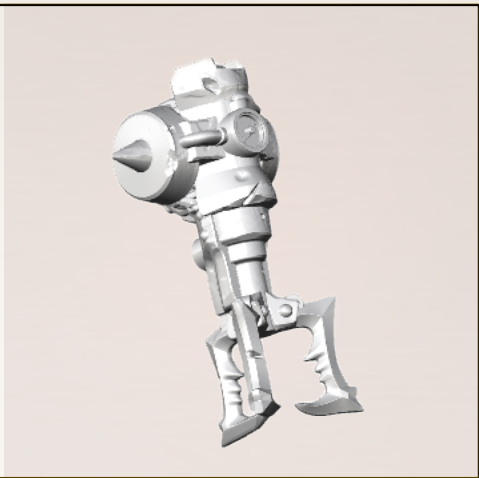
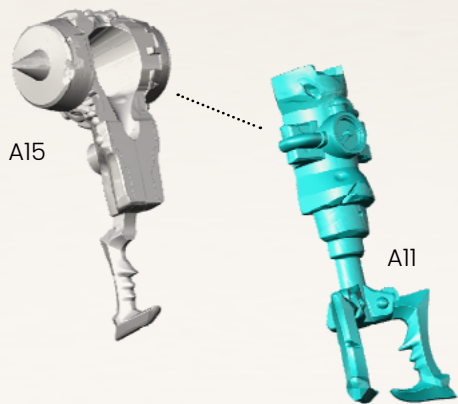

10

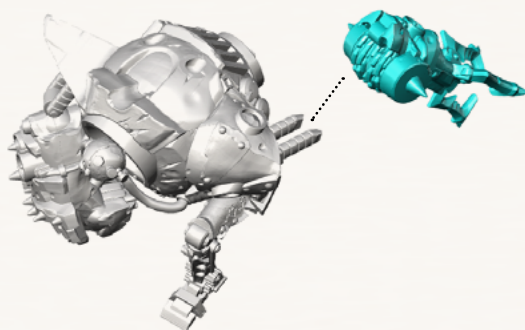

11

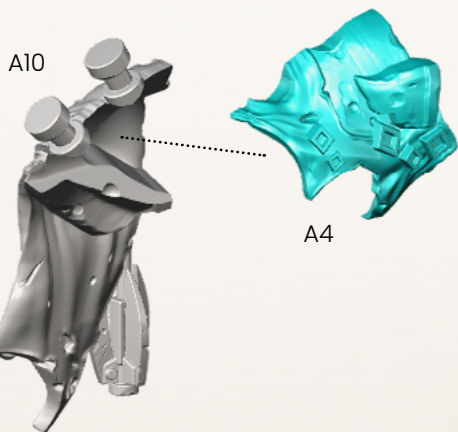

12

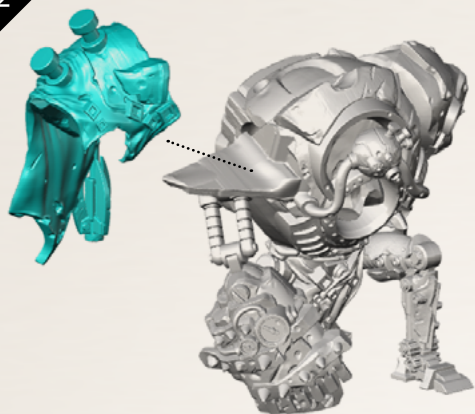

13

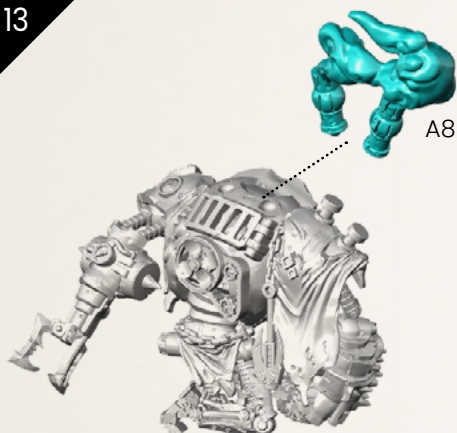

14



SWARM WARRIOR V2

SPRUE: Stretch Goals 5

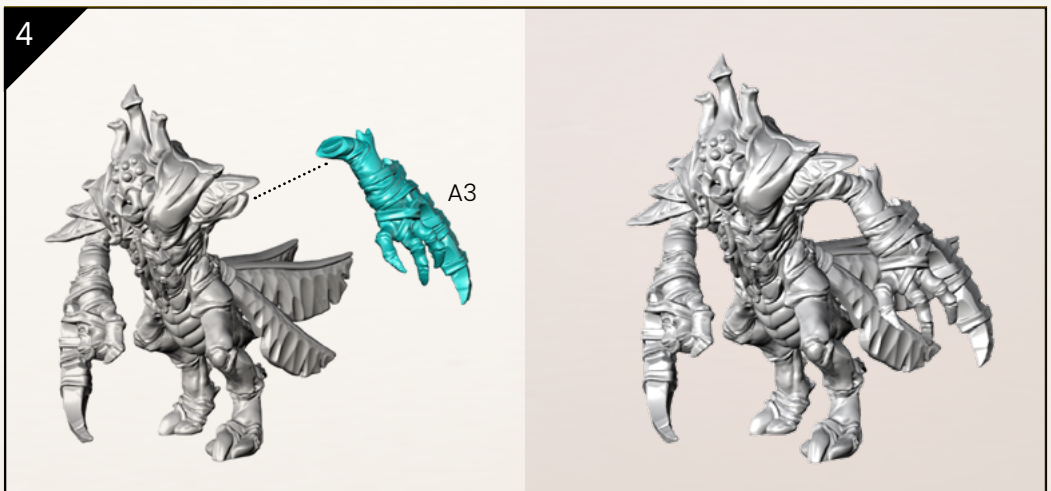
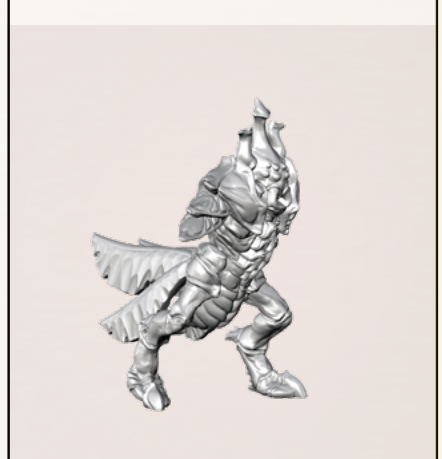
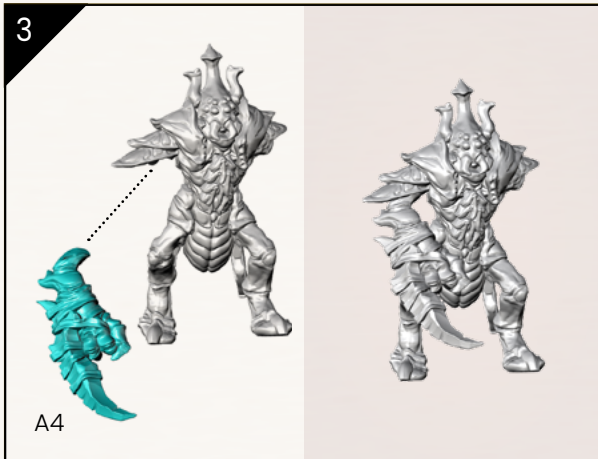
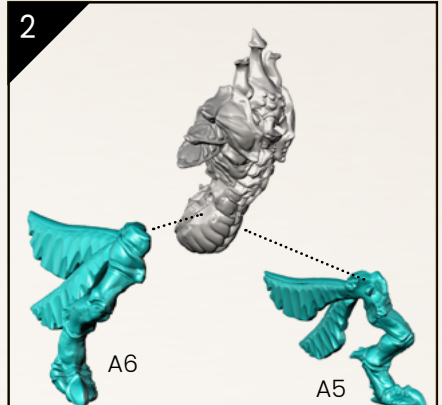
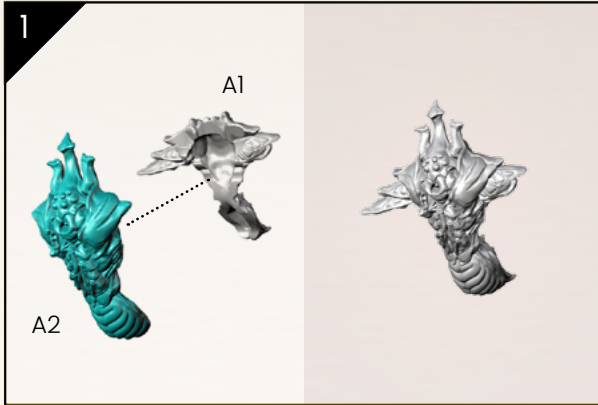



JOIN THE PARTY



DUNGEONSANDLASERS



DUNGEONSANDLASERSOFFICIAL



DUNGEONSANDLASERS.COM



SHOP.ARCHON-STUDIO.COM